

Chapter 5: CPU Scheduling

Chapter 5: CPU Scheduling

- ▶ Basic Concepts
- ▶ Scheduling Criteria
- ▶ Scheduling Algorithms
- ▶ Multiple-Processor Scheduling
- ▶ Real-Time Scheduling
- ▶ Thread Scheduling
- ▶ Operating Systems Examples
- ▶ Java Thread Scheduling
- ▶ Algorithm Evaluation

Basic Concepts

- ▶ Maximum CPU utilization obtained with multiprogramming
- ▶ CPU-I/O Burst Cycle - Process execution consists of a *cycle* of CPU execution and I/O wait
- ▶ CPU burst distribution

Alternating Sequence of CPU And I/O Bursts

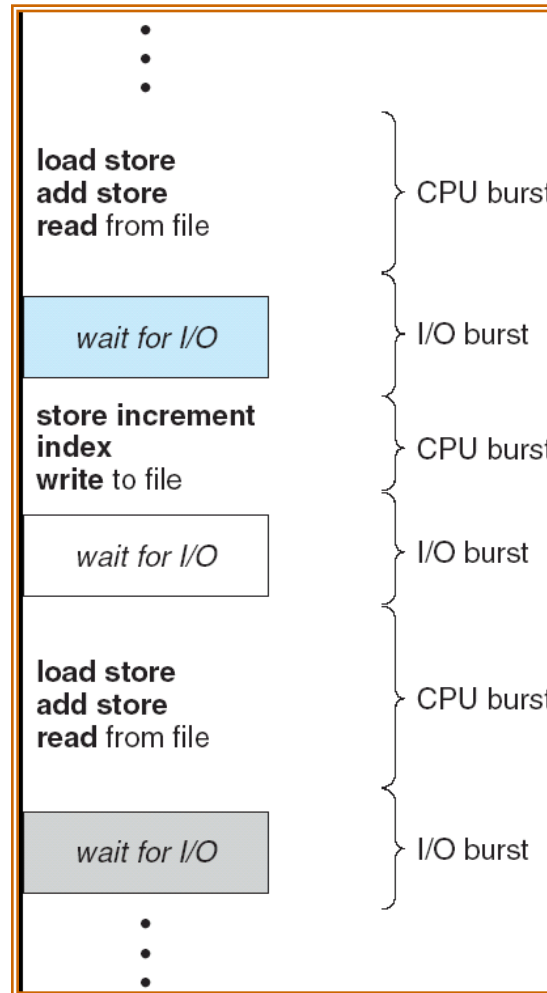

Histogram of CPU-burst Times

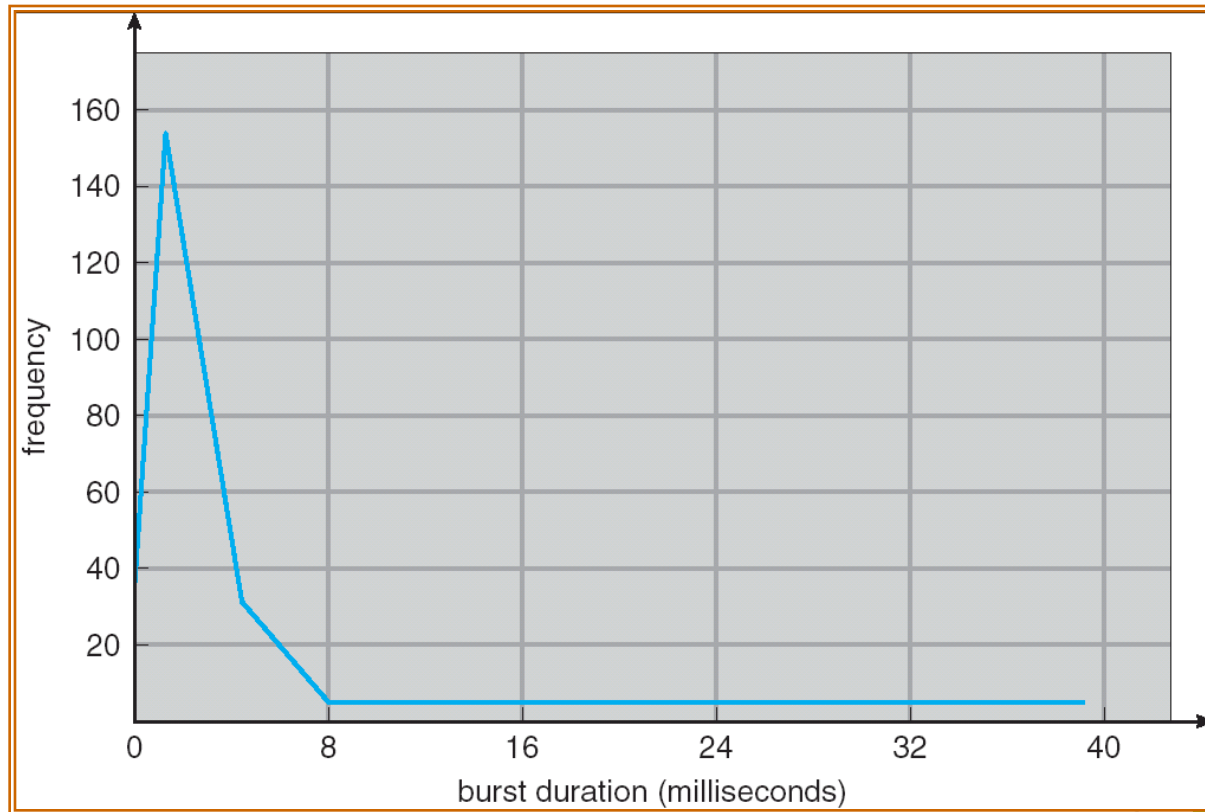

CPU Scheduler

- ▶ Selects from among the processes in memory that are ready to execute, and allocates the CPU to one of them
- ▶ CPU scheduling decisions may take place when a process:
 1. Switches from running to waiting state
 2. Switches from running to ready state
 3. Switches from waiting to ready
 4. Terminates
- ▶ Scheduling under 1 and 4 is *nonpreemptive*
- ▶ All other scheduling is *preemptive*

Dispatcher

- ▶ Dispatcher module gives control of the CPU to the process selected by the short-term scheduler; this involves:
 - ▶ switching context
 - ▶ switching to user mode
 - ▶ jumping to the proper location in the user program to restart that program
- ▶ *Dispatch latency* - time it takes for the dispatcher to stop one process and start another running

Scheduling Criteria

- ▶ CPU utilization - keep the CPU as busy as possible
- ▶ Throughput - # of processes that complete their execution per time unit
- ▶ Turnaround time - amount of time to execute a particular process
- ▶ Waiting time - amount of time a process has been waiting in the ready queue
- ▶ Response time - amount of time it takes from when a request was submitted until the first response is produced, **not output** (for time-sharing environment)

Optimization Criteria

- ▶ Max CPU utilization
- ▶ Max throughput
- ▶ Min turnaround time
- ▶ Min waiting time
- ▶ Min response time

First-Come, First-Served (FCFS) Scheduling

<u>Process</u>	<u>Burst Time</u>
P_1	24
P_2	3
P_3	3

- ▶ Suppose that the processes arrive in the order: P_1, P_2, P_3
The Gantt Chart for the schedule is:



- ▶ Waiting time for $P_1 = 0$; $P_2 = 24$; $P_3 = 27$
- ▶ Average waiting time: $(0 + 24 + 27)/3 = 17$

FCFS Scheduling (Cont.)

Suppose that the processes arrive in the order

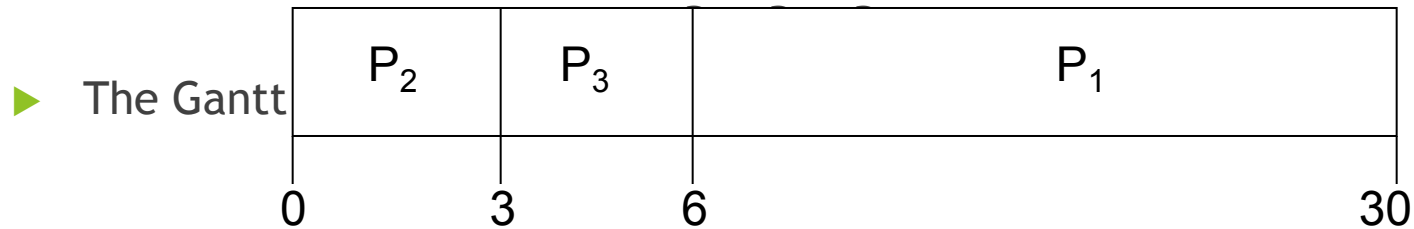

- ▶ Waiting time for $P_1 = 6$; $P_2 = 0$; $P_3 = 3$
- ▶ Average waiting time: $(6 + 0 + 3)/3 = 3$
- ▶ Much better than previous case
- ▶ *Convoy effect* short process behind long process

Shortest-Job-First (SJF) Scheduling

- ▶ Associate with each process the length of its next CPU burst. Use these lengths to schedule the process with the shortest time
- ▶ Two schemes:
 - ▶ nonpreemptive - once CPU given to the process it cannot be preempted until completes its CPU burst
 - ▶ preemptive - if a new process arrives with CPU burst length less than remaining time of current executing process, preempt. This scheme is known as the Shortest-Remaining-Time-First (SRTF)
- ▶ SJF is optimal - gives minimum average waiting time for a given set of processes

Example of Non-Preemptive SJF

<u>Process</u>	<u>Arrival Time</u>	<u>Burst Time</u>
P_1	0.0	7
P_2	2.0	4
P_3	4.0	1
P_4	5.0	4

- ▶ SJF (non-pre)

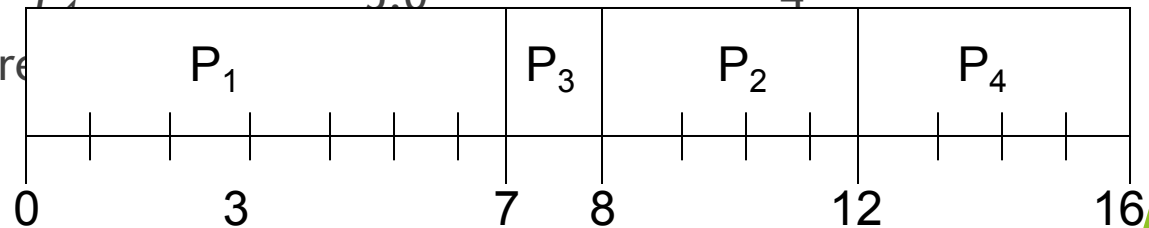

- ▶ Average waiting time = $(0 + 6 + 3 + 7)/4 = 4$

Example of Preemptive SJF

<u>Process</u>	<u>Arrival Time</u>	<u>Burst Time</u>
P_1	0.0	7
P_2	2.0	4
P_3	4.0	1
P_4	5.0	4

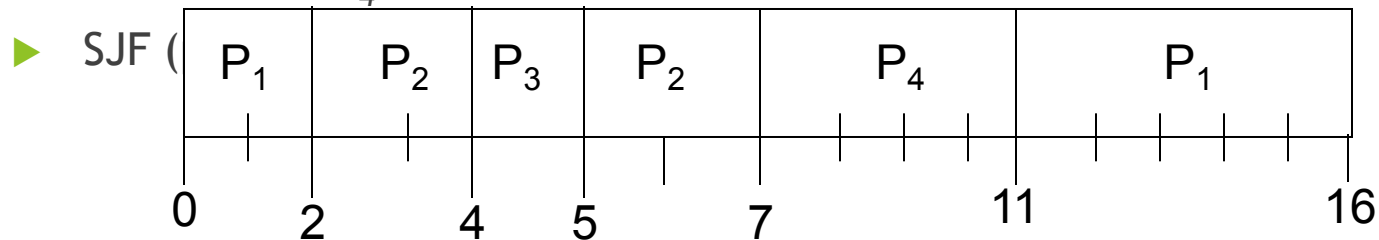

- ▶ Average waiting time = $(9 + 1 + 0 + 2) / 4 = 3$

Priority Scheduling

- ▶ A priority number (integer) is associated with each process
- ▶ The CPU is allocated to the process with the highest priority (smallest integer \equiv highest priority)
 - ▶ Preemptive
 - ▶ nonpreemptive
- ▶ SJF is a priority scheduling where priority is the predicted next CPU burst time
- ▶ Problem \equiv Starvation - low priority processes may never execute
- ▶ Solution \equiv Aging - as time progresses increase the priority of the process

Round Robin (RR)

- ▶ Each process gets a small unit of CPU time (*time quantum*), usually 10-100 milliseconds. After this time has elapsed, the process is preempted and added to the end of the ready queue.
- ▶ If there are n processes in the ready queue and the time quantum is q , then each process gets $1/n$ of the CPU time in chunks of at most q time units at once. No process waits more than $(n-1)q$ time units.
- ▶ Performance
 - ▶ q large \Rightarrow FIFO
 - ▶ q small $\Rightarrow q$ must be large with respect to context switch, otherwise overhead is too high

Example of RR with Time Quantum = 20

<u>Process</u>	<u>Burst Time</u>
P_1	53
P_2	17
P_3	68
P_4	24

- The Gantt chart is:

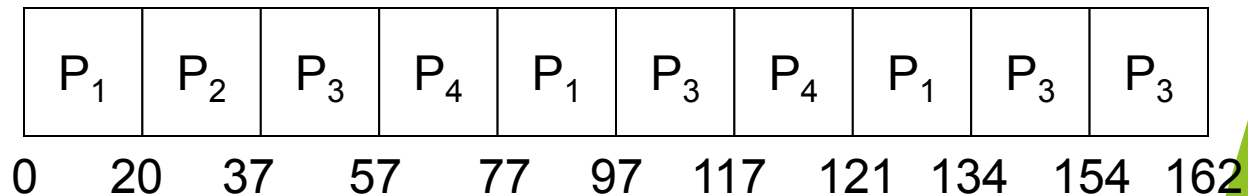

- Typically, higher average turnaround than SJF, but better *response*

Time Quantum and Context Switch Time

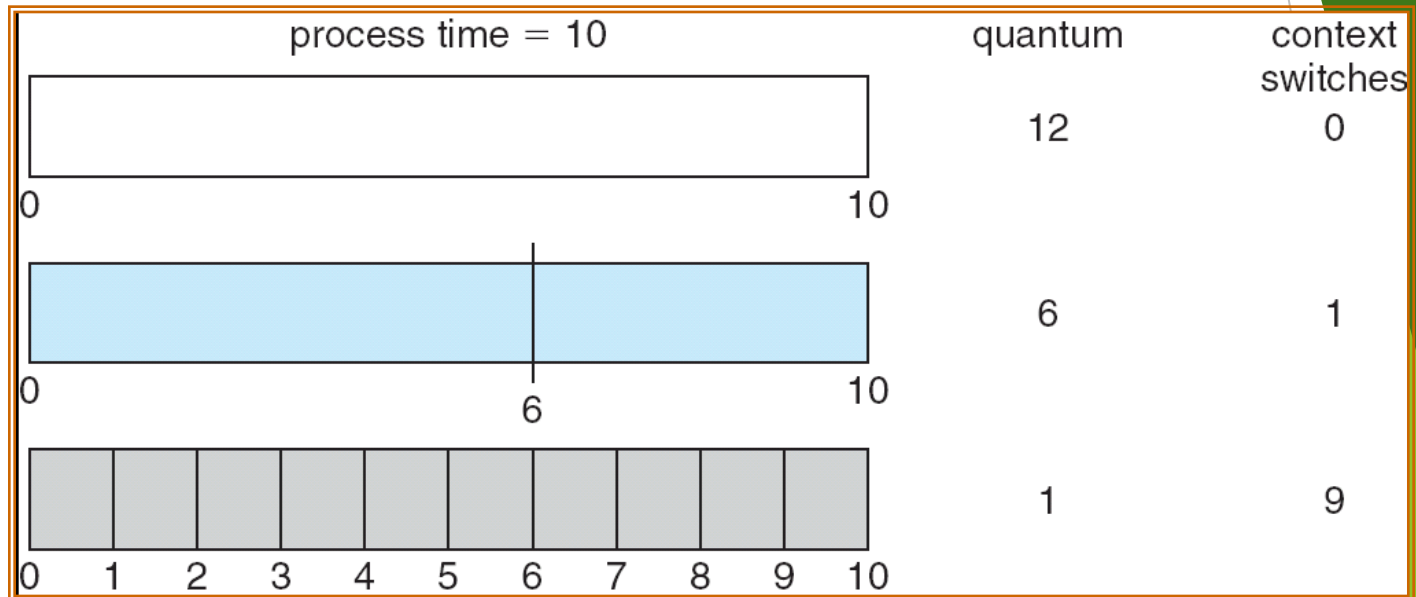

Turnaround Time Varies With The Time Quantum

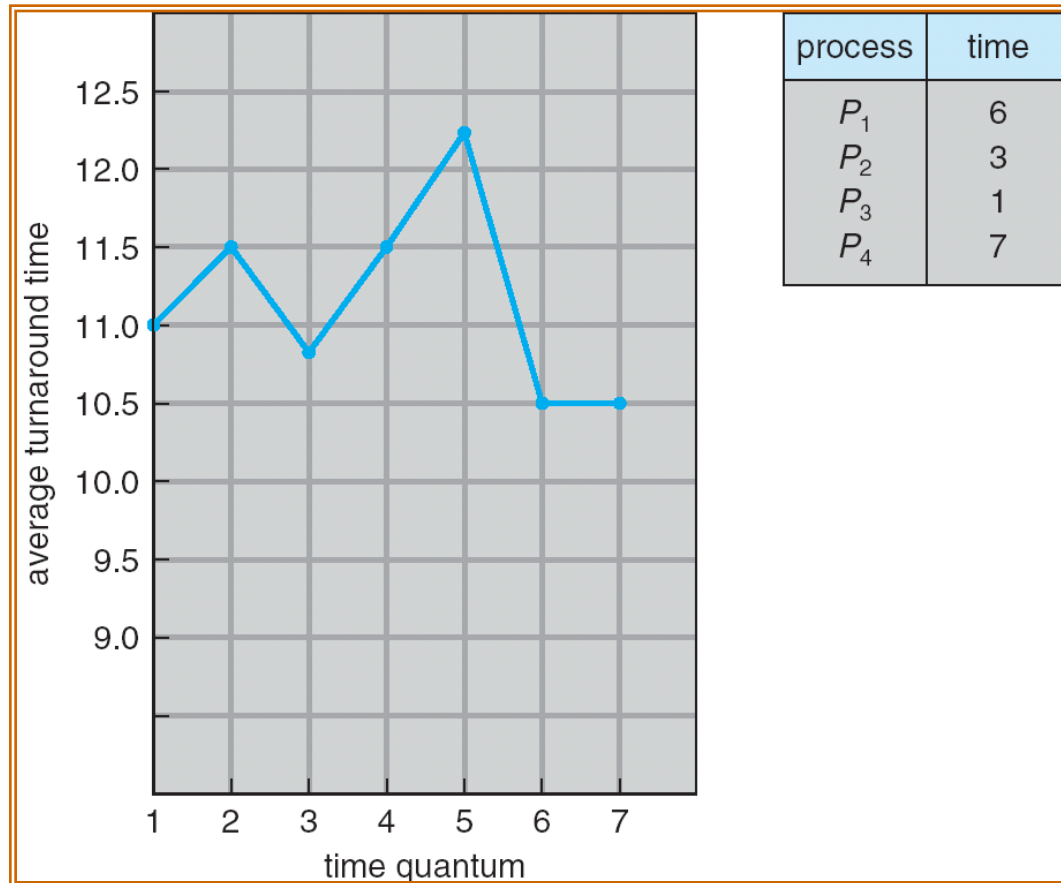

Multilevel Queue

- ▶ Ready queue is partitioned into separate queues:
foreground (interactive)
background (batch)
- ▶ Each queue has its own scheduling algorithm
 - ▶ foreground - RR
 - ▶ background - FCFS
- ▶ Scheduling must be done between the queues
 - ▶ Fixed priority scheduling; (i.e., serve all from foreground then from background). Possibility of starvation.
 - ▶ Time slice - each queue gets a certain amount of CPU time which it can schedule amongst its processes; i.e., 80% to foreground in RR
 - ▶ 20% to background in FCFS

Multilevel Queue Scheduling

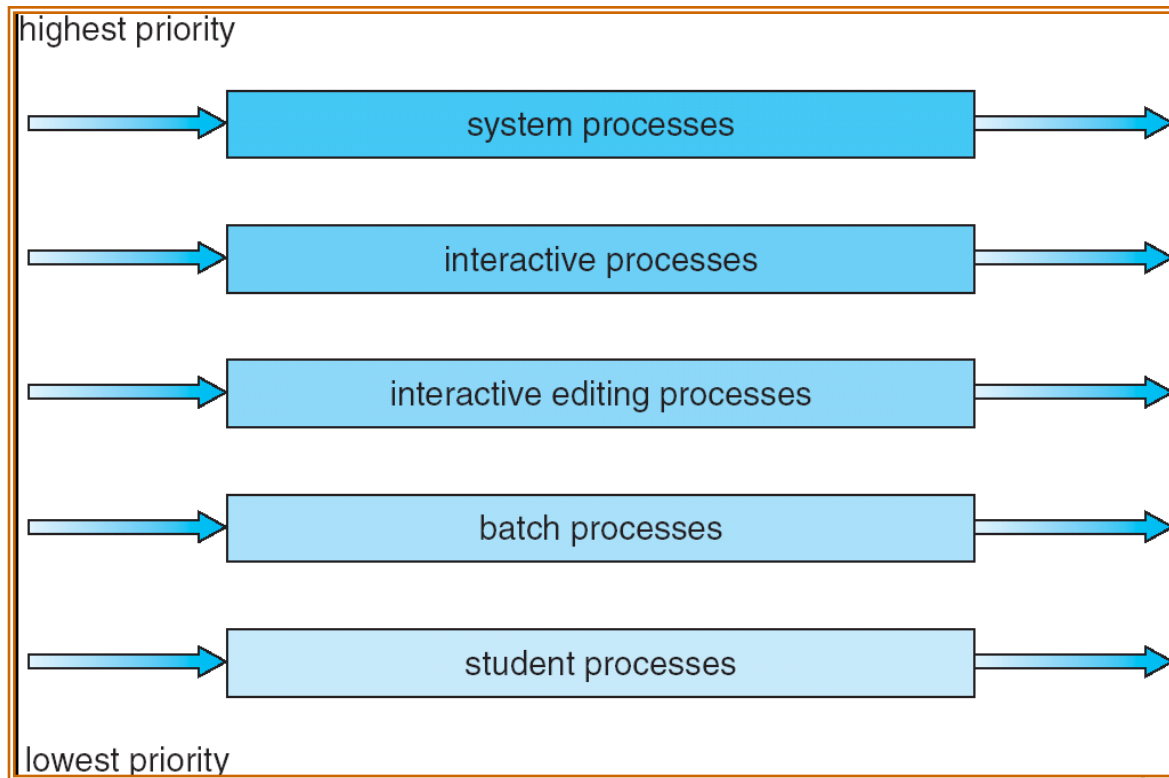

Multilevel Feedback Queue

- ▶ A process can move between the various queues; aging can be implemented this way
- ▶ Multilevel-feedback-queue scheduler defined by the following parameters:
 - ▶ number of queues
 - ▶ scheduling algorithms for each queue
 - ▶ method used to determine when to upgrade a process
 - ▶ method used to determine when to demote a process
 - ▶ method used to determine which queue a process will enter when that process needs service

Example of Multilevel Feedback Queue

- ▶ Three queues:
 - ▶ Q_0 - RR with time quantum 8 milliseconds
 - ▶ Q_1 - RR time quantum 16 milliseconds
 - ▶ Q_2 - FCFS
- ▶ Scheduling
 - ▶ A new job enters queue Q_0 which is served FCFS. When it gains CPU, job receives 8 milliseconds. If it does not finish in 8 milliseconds, job is moved to queue Q_1 .
 - ▶ At Q_1 job is again served FCFS and receives 16 additional milliseconds. If it still does not complete, it is preempted and moved to queue Q_2 .

Multilevel Feedback Queues

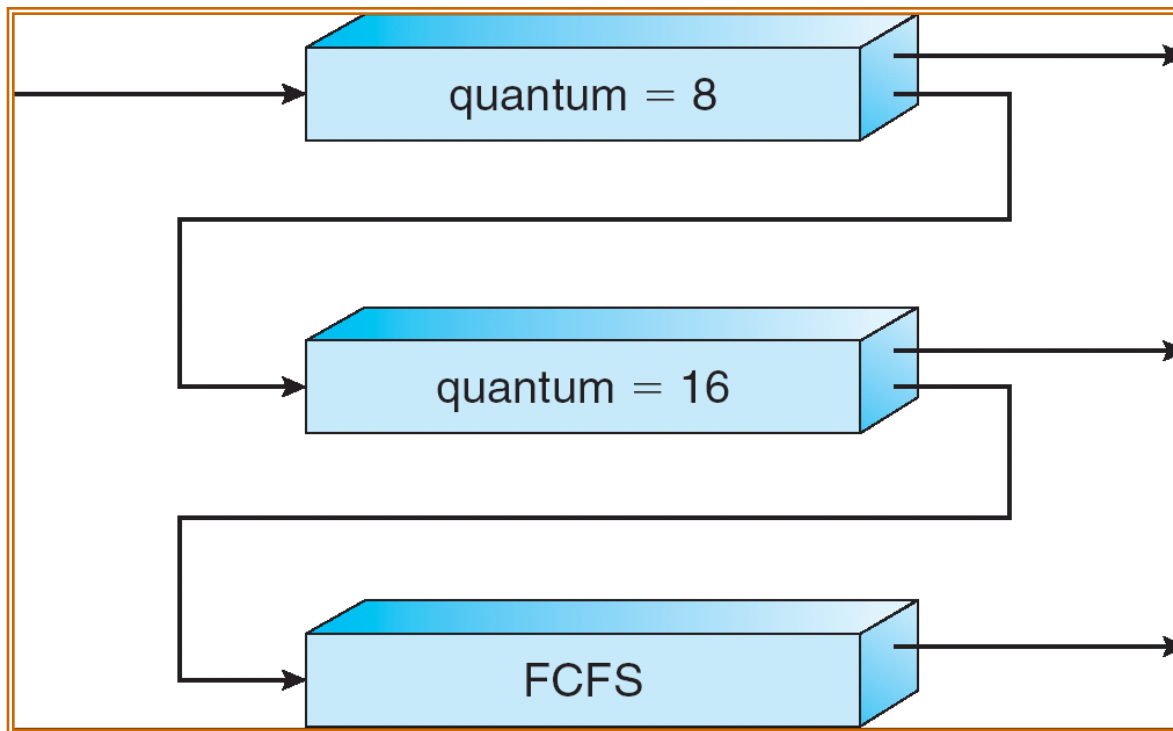

Multiple-Processor Scheduling

- ▶ CPU scheduling more complex when multiple CPUs are available
- ▶ *Homogeneous processors* within a multiprocessor
- ▶ *Load sharing*
- ▶ *Asymmetric multiprocessing* - only one processor accesses the system data structures, alleviating the need for data sharing

Real-Time Scheduling

- ▶ *Hard real-time* systems - required to complete a critical task within a guaranteed amount of time
- ▶ *Soft real-time* computing - requires that critical processes receive priority over less fortunate ones

Thread Scheduling

- ▶ Local Scheduling - How the threads library decides which thread to put onto an available LWP
- ▶ Global Scheduling - How the kernel decides which kernel thread to run next

Pthread Scheduling API

```
#include <pthread.h>
#include <stdio.h>
#define NUM_THREADS 5
int main(int argc, char *argv[])
{
    int i;
    pthread_t tid[NUM_THREADS];
    pthread_attr_t attr;
    /* get the default attributes */
    pthread_attr_t attr;
    pthread_attr_init(&attr);
    /* set the scheduling algorithm to PROCESS or SYSTEM */
    pthread_attr_setscope(&attr, PTHREAD_SCOPE_SYSTEM);
    /* set the scheduling policy - FIFO, RT, or OTHER */
    pthread_attr_setschedpolicy(&attr, SCHED_OTHER);
    /* create the threads */
    for (i = 0; i < NUM_THREADS; i++)
        pthread_create(&tid[i], &attr, runner, NULL);
```

Pthread Scheduling API

```
    /* now join on each thread */
    for (i = 0; i < NUM_THREADS; i++)
        pthread join(tid[i], NULL);
}
/* Each thread will begin control in this function */
void *runner(void *param)
{
    printf("I am a thread\n");
    pthread exit(0);
}
```

Operating System Examples

- ▶ Solaris scheduling
- ▶ Windows XP scheduling
- ▶ Linux scheduling

Solaris 2 Scheduling

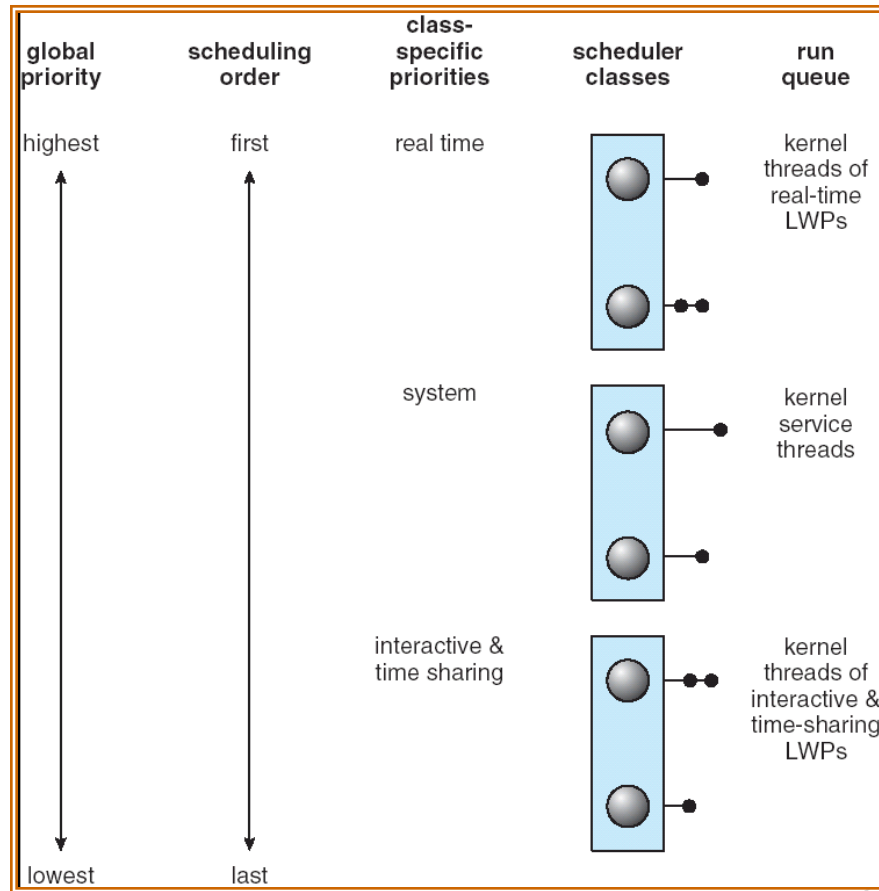

Solaris Dispatch Table

priority	time quantum	time quantum expired	return from sleep
0	200	0	50
5	200	0	50
10	160	0	51
15	160	5	51
20	120	10	52
25	120	15	52
30	80	20	53
35	80	25	54
40	40	30	55
45	40	35	56
50	40	40	58
55	40	45	58
59	20	49	59

Windows XP Priorities

	real-time	high	above normal	normal	below normal	idle priority
time-critical	31	15	15	15	15	15
highest	26	15	12	10	8	6
above normal	25	14	11	9	7	5
normal	24	13	10	8	6	4
below normal	23	12	9	7	5	3
lowest	22	11	8	6	4	2
idle	16	1	1	1	1	1

Linux Scheduling

- ▶ Two algorithms: time-sharing and real-time
- ▶ Time-sharing
 - ▶ Prioritized credit-based - process with most credits is scheduled next
 - ▶ Credit subtracted when timer interrupt occurs
 - ▶ When credit = 0, another process chosen
 - ▶ When all processes have credit = 0, recrediting occurs
 - ▶ Based on factors including priority and history
- ▶ Real-time
 - ▶ Soft real-time
 - ▶ Posix.1b compliant - two classes
 - ▶ FCFS and RR
 - ▶ Highest priority process always runs first

The Relationship Between Priorities and Time-slice length

numeric priority	relative priority		time quantum
0	highest	real-time tasks	200 ms
•			
•			
•			
99			
100			
•			
•			
•			
140	lowest	other tasks	10 ms

List of Tasks Indexed According to Priorities

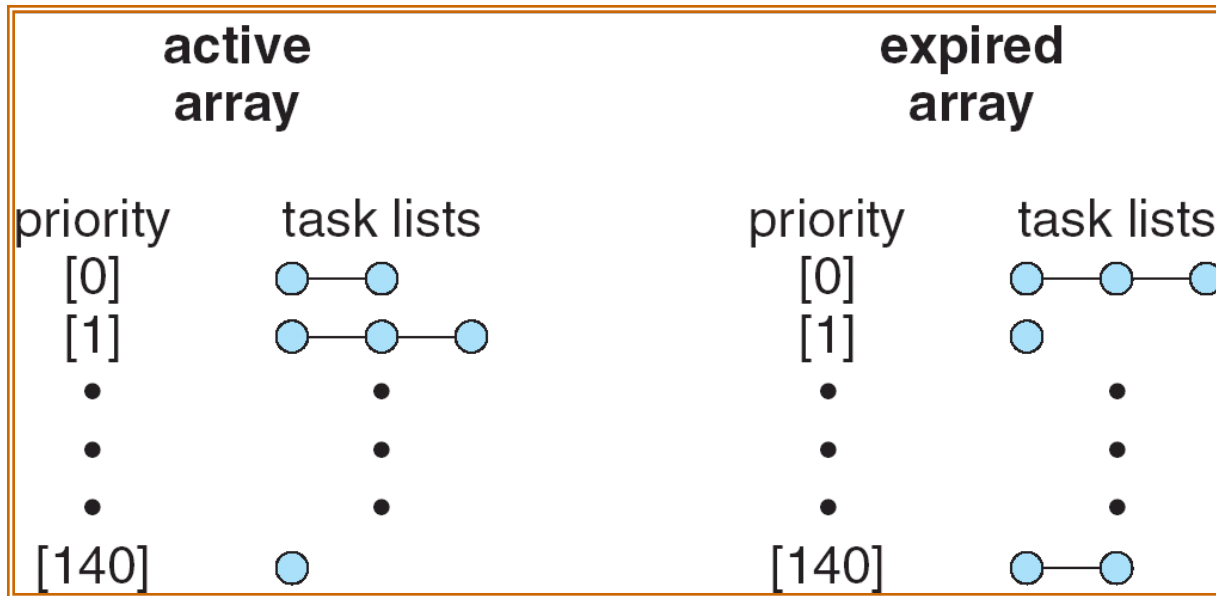

Algorithm Evaluation

- ▶ Deterministic modeling - takes a particular predetermined workload and defines the performance of each algorithm for that workload
- ▶ Queueing models
- ▶ Implementation

5.15

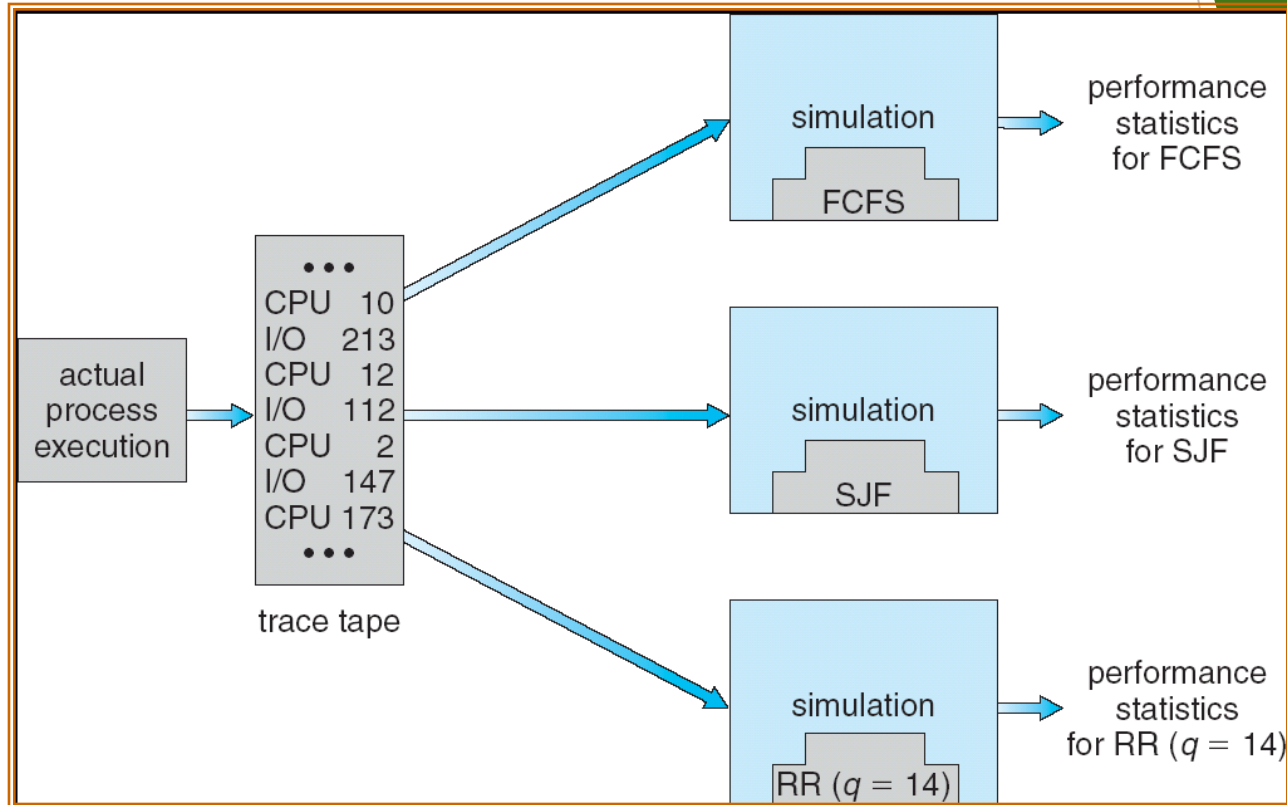

5.08

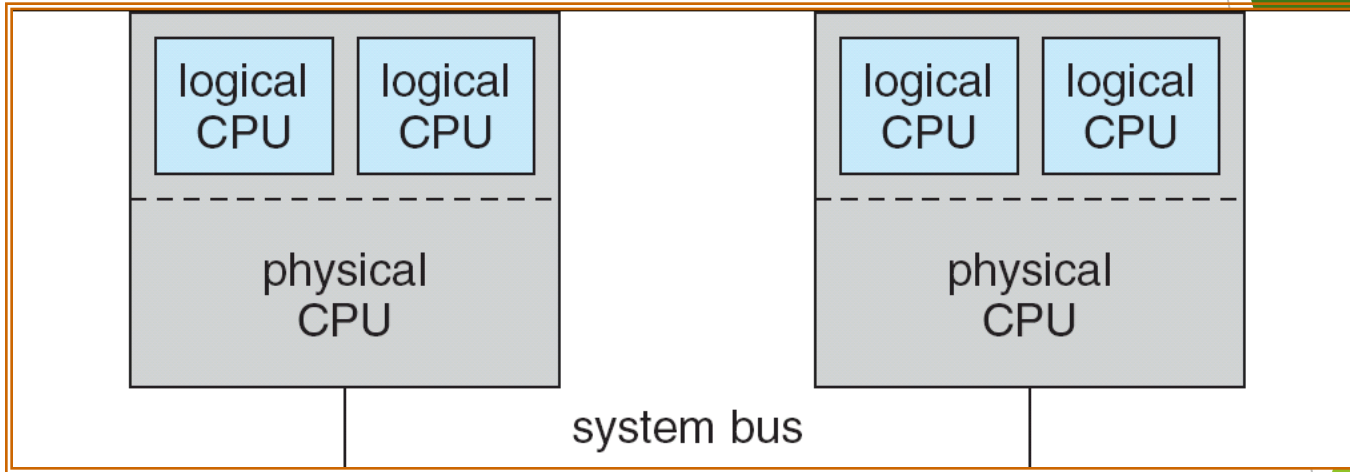

In-5.7

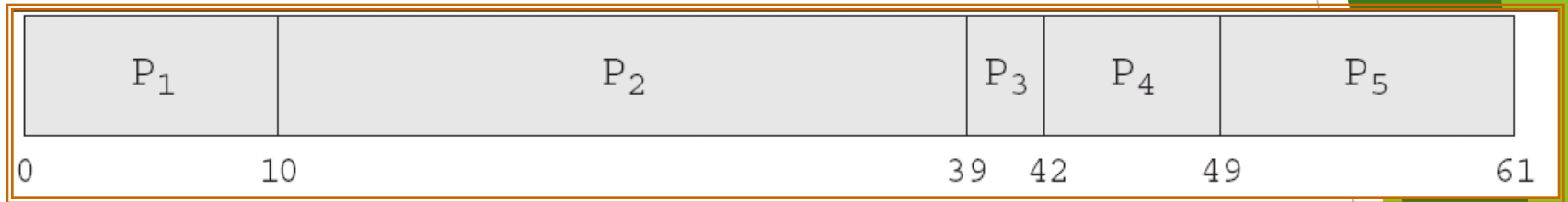

In-5.8

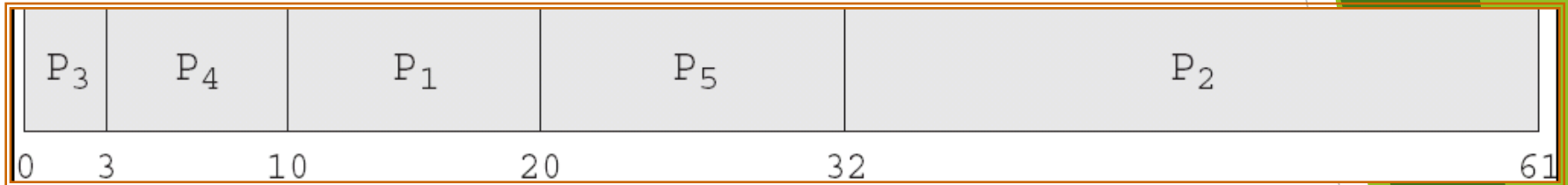

In-5.9

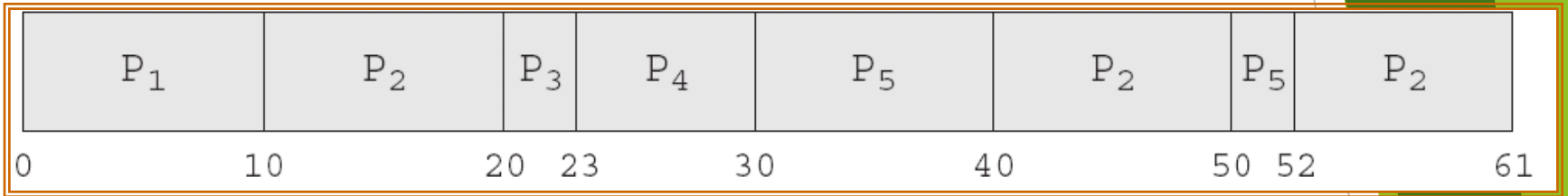

Dispatch Latency

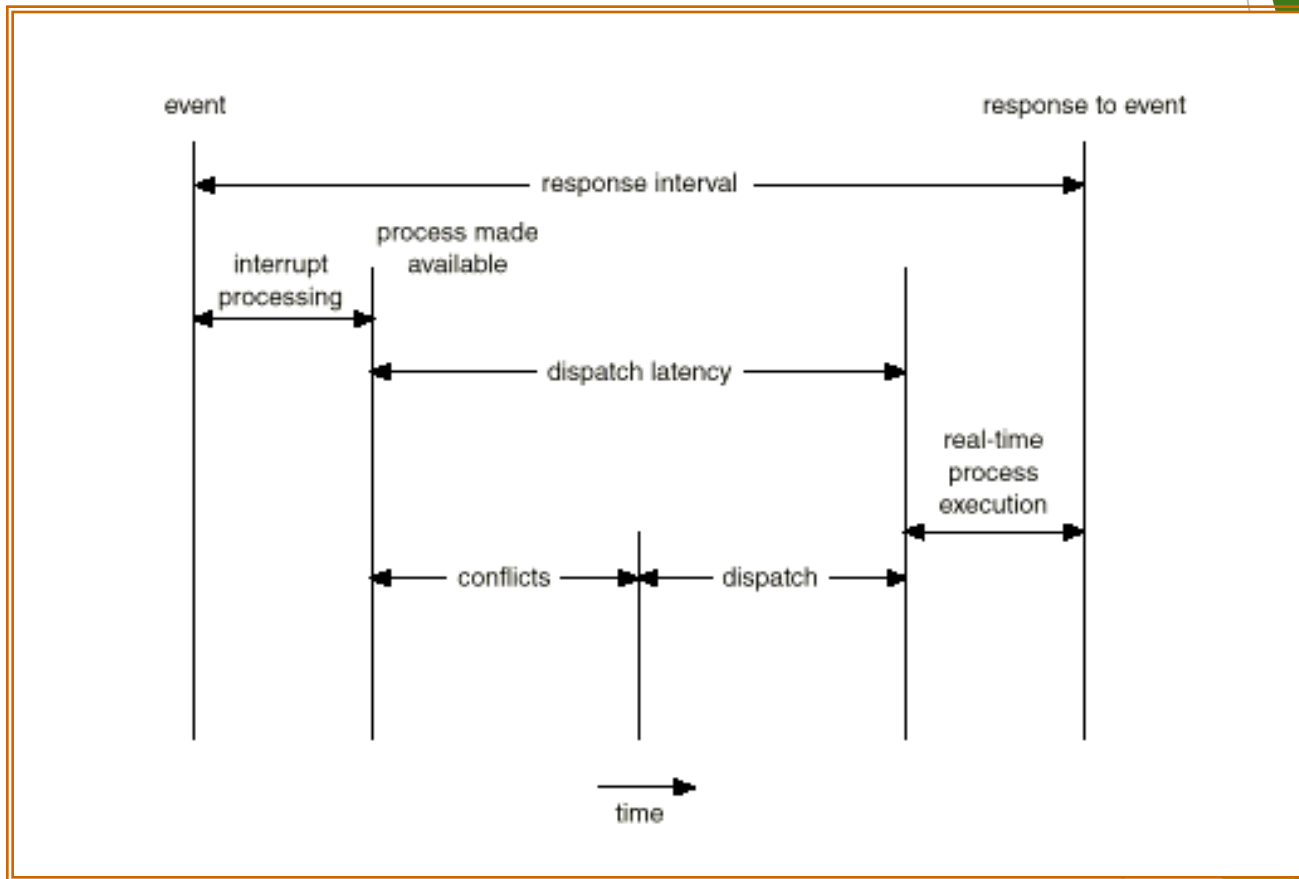

Java Thread Scheduling

- ▶ JVM Uses a Preemptive, Priority-Based Scheduling Algorithm
- ▶ FIFO Queue is Used if There Are Multiple Threads With the Same Priority

Java Thread Scheduling (cont)

JVM Schedules a Thread to Run When:

1. The Currently Running Thread Exits the Runnable State
2. A Higher Priority Thread Enters the Runnable State

* Note - the JVM Does Not Specify Whether Threads are Time-Sliced or Not

Time-Slicing

Since the JVM Doesn't Ensure Time-Slicing, the `yield()` Method May Be Used:

```
while (true) {  
    // perform CPU-intensive task  
    . . .  
    Thread.yield();  
}
```

This Yields Control to Another Thread of Equal Priority

Thread Priorities

<u>Priority</u>	<u>Comment</u>
Thread.MIN_PRIORITY	Minimum Thread Priority
Thread.MAX_PRIORITY	Maximum Thread Priority
Thread.NORM_PRIORITY	Default Thread Priority

Priorities May Be Set Using `setPriority()` method:

```
setPriority(Thread.NORM_PRIORITY + 2);
```