

Newton's ring

1. Set-up apparatus

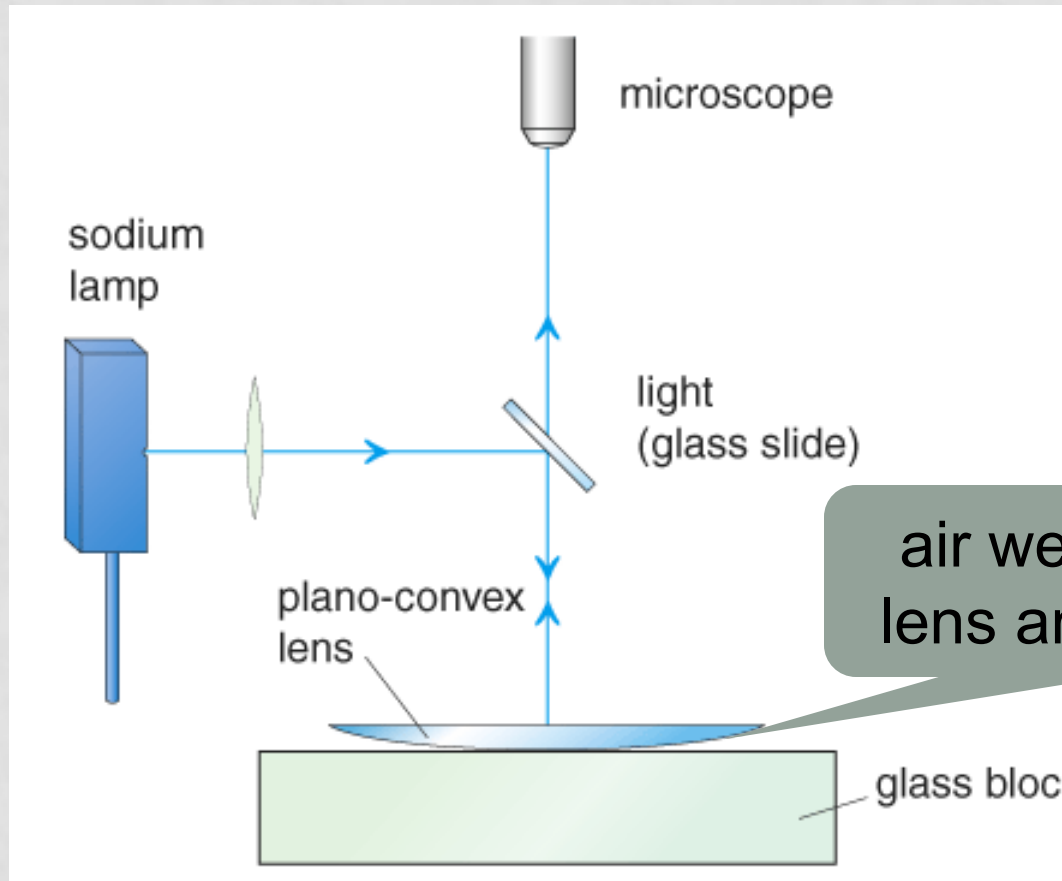

air wedge between
lens and glass block

Newton's ring

1. Set-up apparatus

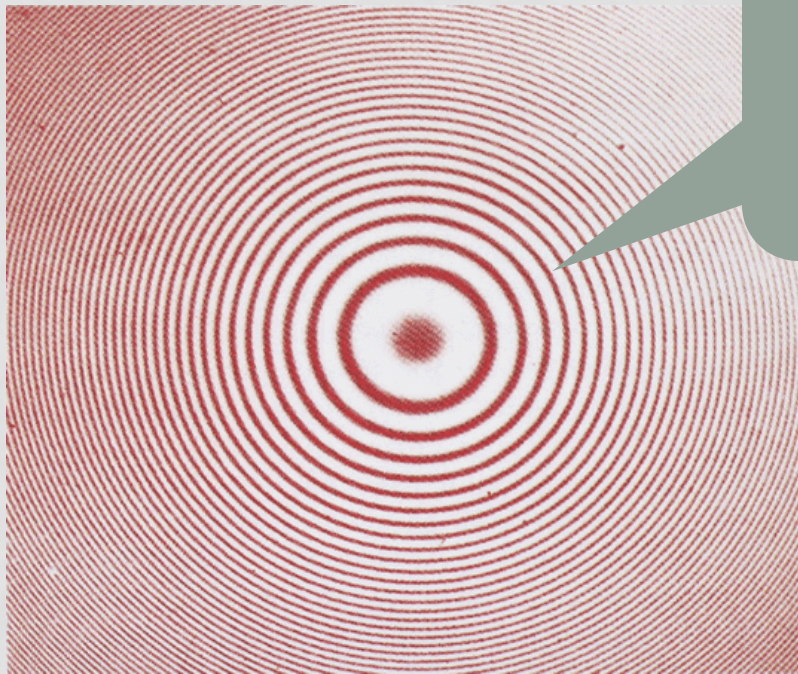

a series of dark and bright rings formed
(**Newton's rings**)

Newton's ring

2. Theory

ray 1 reflected
(no phase change)

ray 2 reflected
(phase change of π)

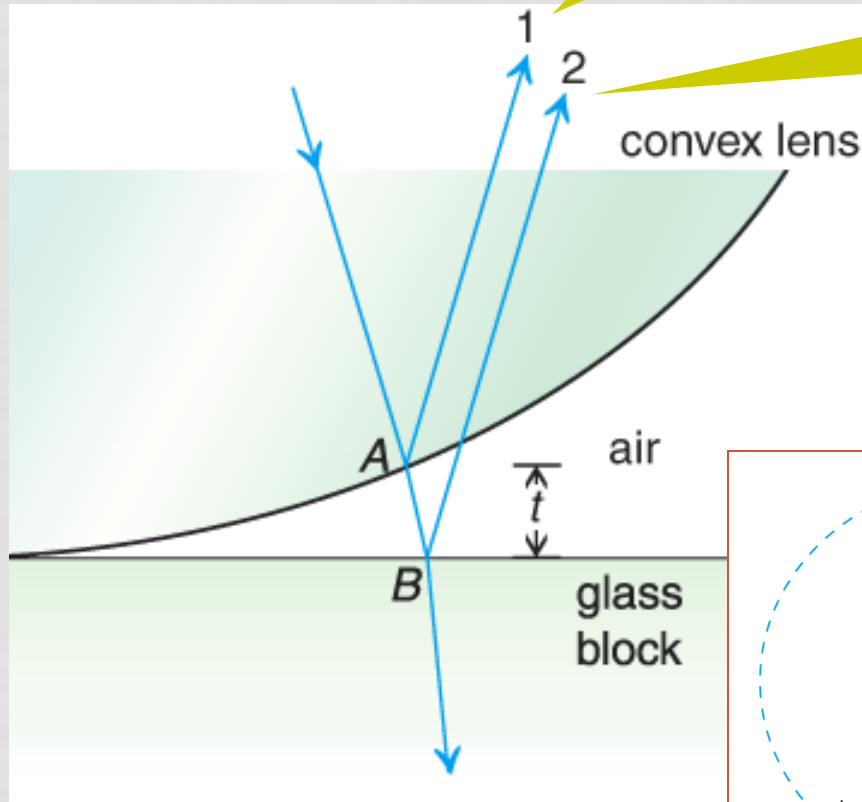

For constructive interference :

$$2t = \left(m - \frac{1}{2}\right)\lambda$$

For desctructive interference :

$$2t = m\lambda$$

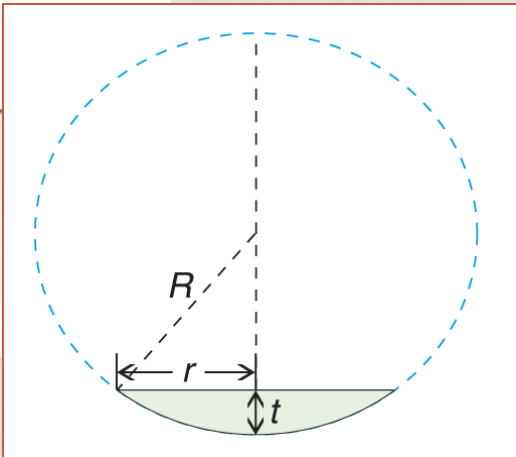

$$(R - t)^2 + r^2 = R^2$$

$$r^2 = 2Rt$$

(for large R , small t)

For dark rings

$$r^2 = mR\lambda$$

Newton's ring

2. Theory

Note:

1. By $d = \frac{\lambda}{2 \tan \theta}$, as the thickness of the air film increases gradually outwards non-uniformly, the separation between the fringes decreases.
2. If white light is used, coloured rings will be observed. For a given ring, the inner side is violet and outer side is red. This is because the radius is proportional to the square root of wavelength and red light has longer wavelength.

Go to

More to Know 5

Newton's ring

2. Theory

Note:

3. It is a dark spot at the centre of the lens. The path difference of the two reflected light is zero, but there is a 180° phase change on ray 2. Therefore, an half wavelength path difference exists between the two rays. Thus, destructive interference occurs at centre.

4. If the interference pattern is viewed from below the glass block, reversed bright and dark fringes will be observed, i.e. the centre becomes a bright spot. This is because of the two 180° phase changes due to the ray reflected twice by an optically denser medium. Thus, the transmitted rays are in phase.



End



More to Know 3



Normal incidence

Practically, it is difficult to observe the interference pattern if the light is incident on the parallel-sided thin film normally. For this case, only a single bright or dark patch can be seen.

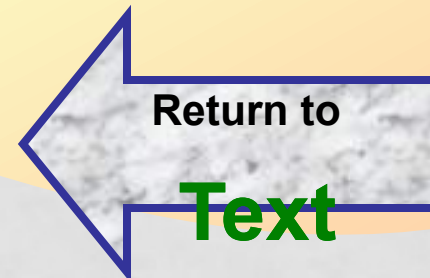



More to Know 4



Liquid film

If some liquid is trapped between the slide and the glass block, the separation of fringes will decrease. Since $\lambda' = \frac{\lambda}{n}$

where $n =$ refractive index, $d = \frac{\lambda' n}{2 \tan \theta}$

becomes smaller.

Return to

Text

Example 17



- Q:** THE FIGURE SHOWS A DROP OF OIL (REFRACTIVE INDEX $n_{\text{OIL}} = 1.20$) FLOATING ON THE SURFACE OF WATER (REFRACTIVE INDEX $n_{\text{WATER}} = 1.33$) AND THE REFLECTED LIGHT IS OBSERVED ON THE TOP.
- (A) EXPLAIN WHETHER THE OUTER REGION (WHICH IS THE THINNEST) CORRESPONDS TO A BRIGHT OR DARK FRINGE.
- (B) IF BLUE LIGHT OF WAVELENGTH 450 NM IS INCIDENT ON THE OIL DROP, ESTIMATE THE THICKNESS OF THE OIL AT THE POSITION OF THE THIRD BRIGHT FRINGE FROM THE OUTSIDE.
- (C) EXPLAIN WHY THE INTERFERENCE FRINGES CANNOT BE SEEN WHEN THE THICKNESS OF THE OIL INCREASES.

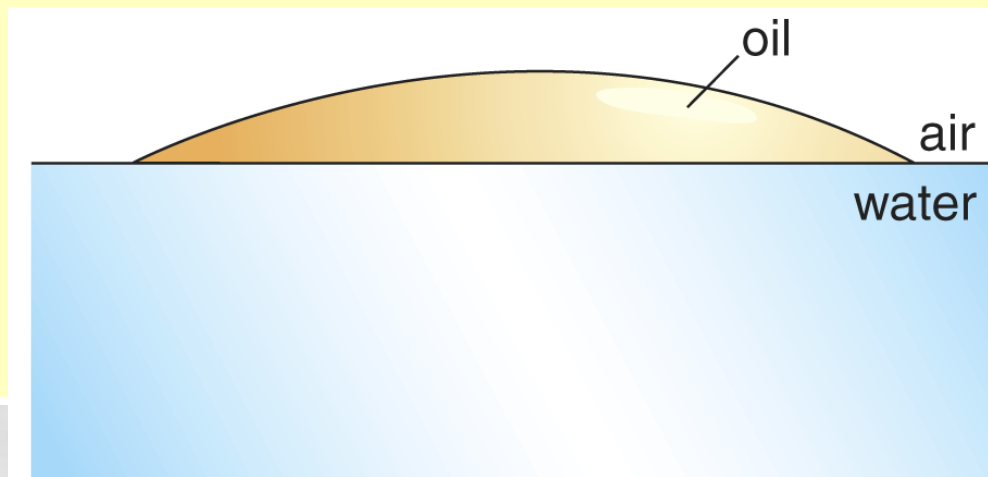

Solution

Example 17

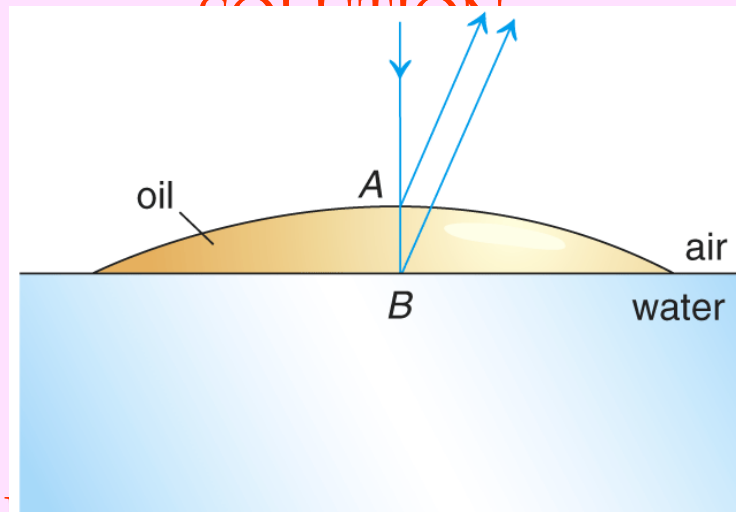

(A) IN THE FIGURE ABOVE, LIGHT REFLECTED AT A, A PHASE CHANGE OF π RADIANS OCCURS SINCE LIGHT IS REFLECTED AT THE OIL SURFACE (NOTE THAT OIL IS OPTICALLY DENSER THAN AIR). AT B, THE REFLECTED LIGHT ALSO EXPERIENCES A PHASE CHANGE OF π RADIANS BECAUSE LIGHT IS REFLECTED FROM WATER AND $N_{\text{WATER}} > N_{\text{OIL}}$. HENCE, THE TWO REFLECTED RAYS ARE IN PHASE. IF $T =$ THICKNESS OF THE OIL FILM, THEN THE PATH DIFFERENCE BETWEEN THE TWO REFLECTED LIGHT RAYS IS $2NT$ WHERE $N =$ REFRACTIVE INDEX OF OIL. AT THE OUTER EDGE, $T = 0$. HENCE THE PATH DIFFERENCE = 0 AND A BRIGHT FRINGE IS OBSERVED.

Example 17



SOLUTION (CONT'D):

(B) FOR THE THIRD BRIGHT FRINGE FROM THE EDGE, $M = 3$.

FROM THE EQUATION $2nT = M\lambda$

$$= 3\lambda$$

\therefore THICKNESS OF THE OIL FILM, $T = \frac{3\lambda}{2n}$

$$\frac{3 \times (450 \times 10^{-9})}{2 \times 1.20} = 560 \text{ NM}$$

(C) AS THE OIL FILM GETS THICKER, THE SEPARATION BETWEEN NEIGHBOURING FRINGES GETS SMALLER UNTIL THE EYE IS NOT ABLE TO RESOLVE THEM.

Return to

Text

More to Know 5

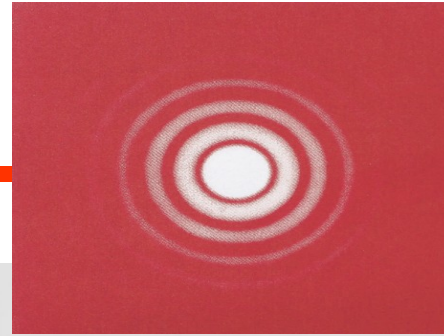

Energy conservation

As the rings produced by the transmitted light are complementary to that by the reflected light, i.e. constructive interference on one side of the film while destructive interference on the other side, it shows that energy is conserved.

Return to

Text