

Amplitude Shift Keying (ASK)

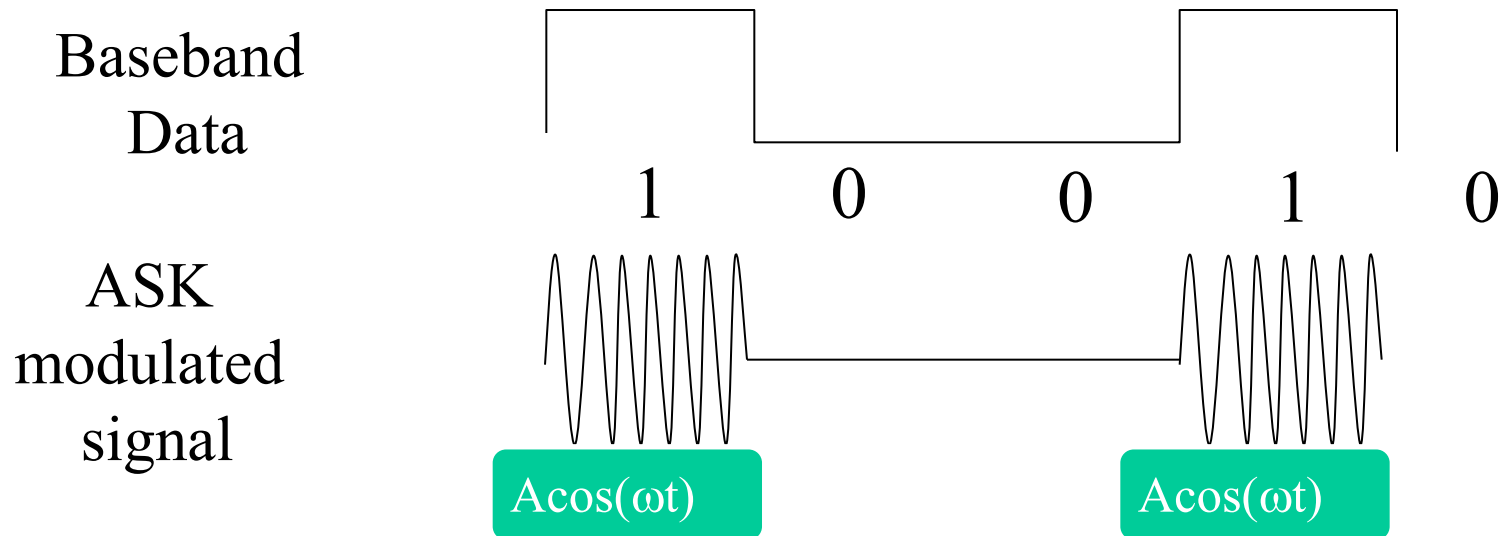

- Pulse shaping can be employed to remove spectral spreading
- ASK demonstrates poor performance, as it is heavily affected by noise, fading, and interference

Frequency Shift Keying (FSK)

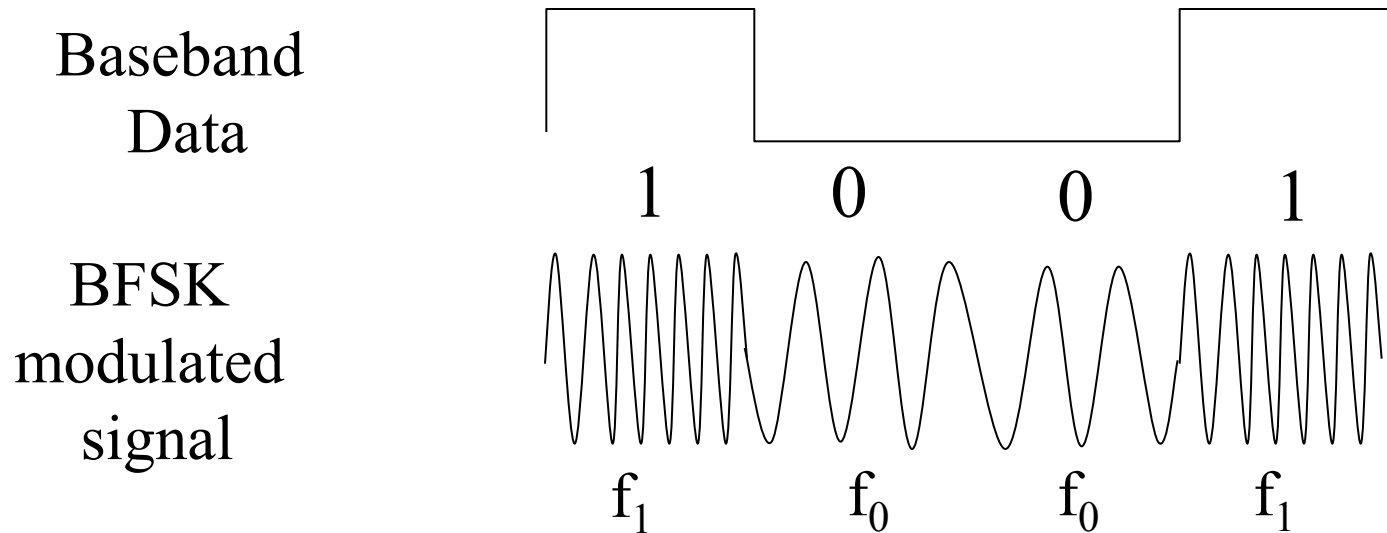

where $f_0 = A\cos(\omega_c - \Delta\omega)t$ and $f_1 = A\cos(\omega_c + \Delta\omega)t$

- Example: The ITU-T V.21 modem standard uses FSK
- FSK can be expanded to a M-ary scheme, employing multiple frequencies as different states

Phase Shift Keying (PSK)

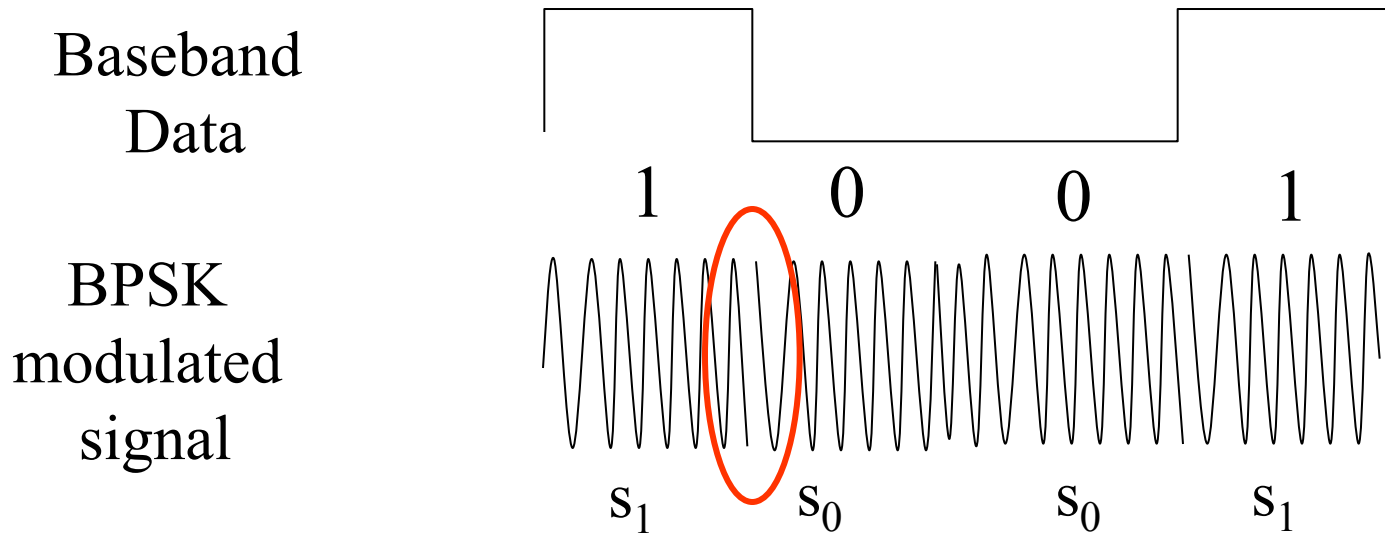

where $s_0 = -A\cos(\omega_c t)$ and $s_1 = A\cos(\omega_c t)$

- Major drawback – rapid amplitude change between symbols due to phase discontinuity, which requires infinite bandwidth. Binary Phase Shift Keying (BPSK) demonstrates better performance than ASK and BFSK
- BPSK can be expanded to a M-ary scheme, employing multiple phases and amplitudes as different states

Differential Modulation

- In the transmitter, each symbol is modulated relative to the previous symbol and modulating signal, for instance in BPSK
 - $0 = \text{no change,}$
 - $1 = +180^\circ$
- In the receiver, the current symbol is demodulated using the previous symbol as a reference. The previous symbol serves as an estimate of the channel. A no-change condition causes the modulated signal to remain at the same 0 or 1 state of the previous symbol.

DPSK

- Differential modulation is theoretically 3dB poorer than coherent. This is because the differential system has 2 sources of error: a corrupted symbol, and a corrupted reference (the previous symbol)
- **DPSK = Differential phase-shift keying:** In the transmitter, each symbol is modulated relative to (a) the phase of the immediately preceding signal element and (b) the data being transmitted.

Pulse Carrier

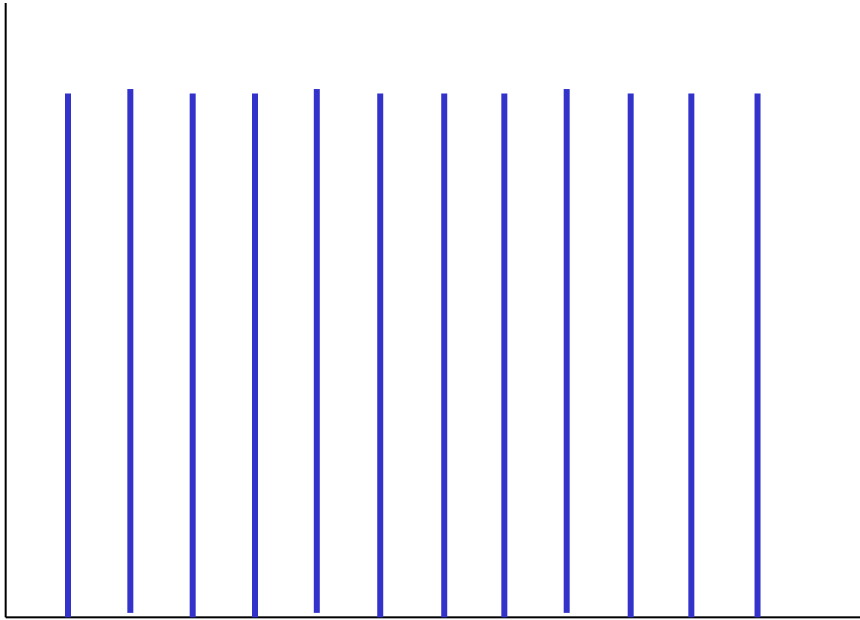

- Carrier:
A train of identical pulses regularly spaced in time

Pulse-Amplitude Modulation (PAM)

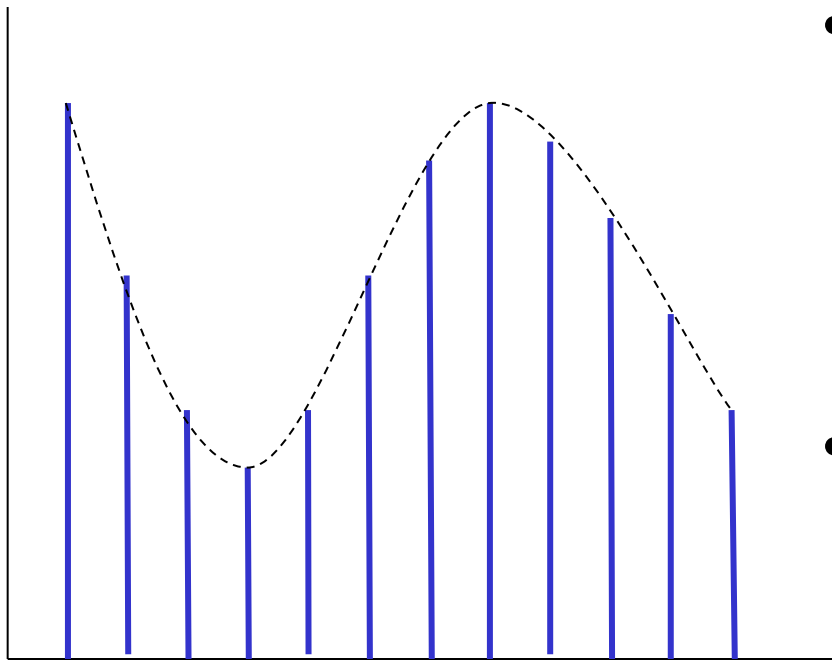

- Modulation in which the amplitude of pulses is varied in accordance with the modulating signal.
- Used e.g. in telephone switching equipment such as a private branch exchange (PBX)

Pulse-Duration Modulation (PDM)

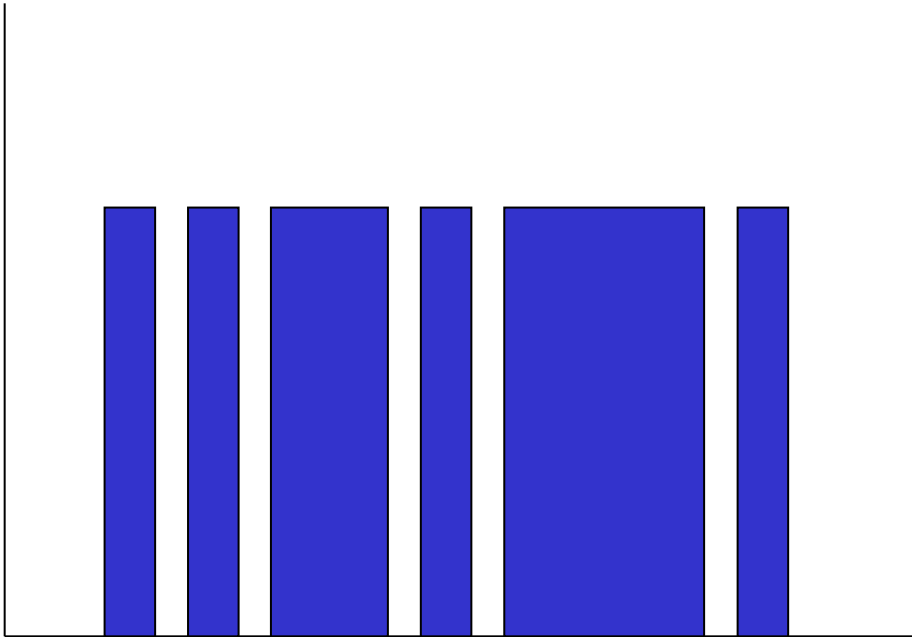

Modulation in which the duration of pulses is varied in accordance with the modulating signal.

Deprecated synonyms:

- pulse-length modulation
- pulse-width modulation

Pulse-Position Modulation (PPM)

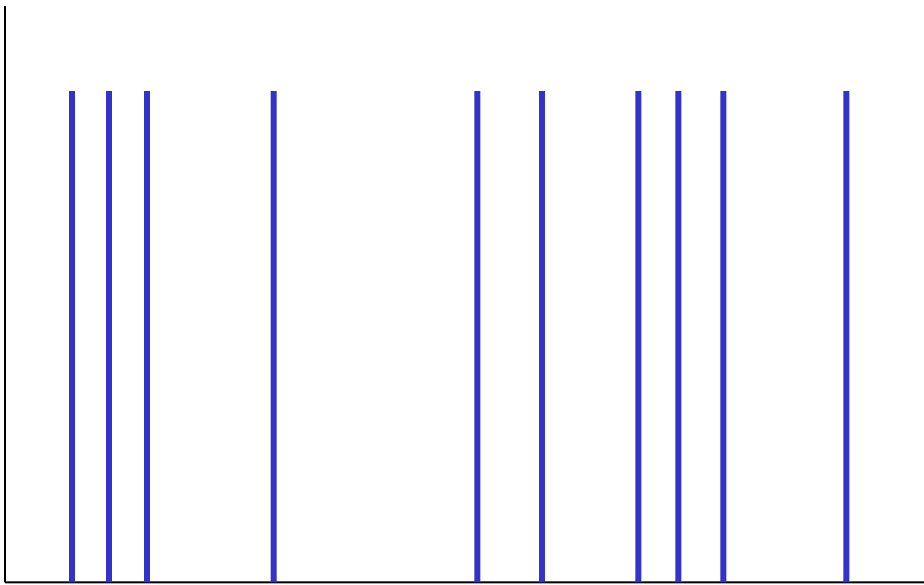

- Modulation in which the temporal positions of the pulses are varied in accordance with some characteristic of the modulating signal.

Demodulation & Detection

- Demodulation
 - Is process of removing the carrier signal to obtain the original signal **waveform**
- Detection – extracts the symbols from the **waveform**
 - Coherent detection
 - Non-coherent detection

Coherent Detection [1]

- An estimate of the channel phase and attenuation is recovered. It is then possible to reproduce the transmitted signal and demodulate.
- **Requires a replica carrier** wave of the same frequency and phase at the receiver.
- The received signal and replica carrier are cross-correlated using information contained in their amplitudes and phases.
- Also known as **synchronous detection**

Coherent Detection [2]

- Applicable to
 - Phase Shift Keying (PSK)
 - Frequency Shift Keying (FSK)
 - Amplitude Shift Keying (ASK)

Non-Coherent Detection

- **Requires no reference wave**; does not exploit phase reference information (envelope detection)
 - Differential Phase Shift Keying (DPSK)
 - Frequency Shift Keying (FSK)
 - Amplitude Shift Keying (ASK)
- Non coherent detection is less complex than coherent detection (easier to implement), but has worse performance.

Geometric Representation

- Digital modulation involves choosing a particular signal $s_i(t)$ from a finite set S of possible signals.
- For binary modulation schemes a binary information bit is mapped directly to a signal and S contains only 2 signals, representing 0 and 1.
- For M -ary keying S contains more than 2 signals and each represents more than a single bit of information. With a signal set of size M , it is possible to transmit up to $\log_2 M$ bits per signal.

Geometric Representation

- Any element of set S can be represented as a point in a vector space whose coordinates are basis signals $\phi_j(t)$ such that

$$\int_{-\infty}^{\infty} \phi_i(t) \phi_j(t) dt = 0, i \neq j; (= \text{are orthogonal})$$

$$E = \int_{-\infty}^{\infty} [\phi_i(t)]^2 dt = 1; (= \text{normalization})$$

$$\text{Then } s_i(t) = \sum_{j=1}^N s_{ij} \phi_j(t)$$

Example: BPSK Constellation Diagram

$$S_{BPSK} = \left\{ \left[s_1(t) = \sqrt{\frac{2E_b}{T_b}} \cos(2\pi f_c t) \right], \left[s_2(t) = -\sqrt{\frac{2E_b}{T_b}} \cos(2\pi f_c t); \right] \right\}; \quad 0 \leq t \leq T_b$$

E_b = energy per bit; T_b = bit period

For this signal set, there is a single basic signal

$$\phi_1(t) = \sqrt{\frac{2}{T_b}} \cos(2\pi f_c t); \quad 0 \leq t \leq T_b$$

$$S_{BPSK} = \left\{ \left[\sqrt{E_b} \phi_1(t) \right], \left[-\sqrt{E_b} \phi_1(t) \right] \right\}$$

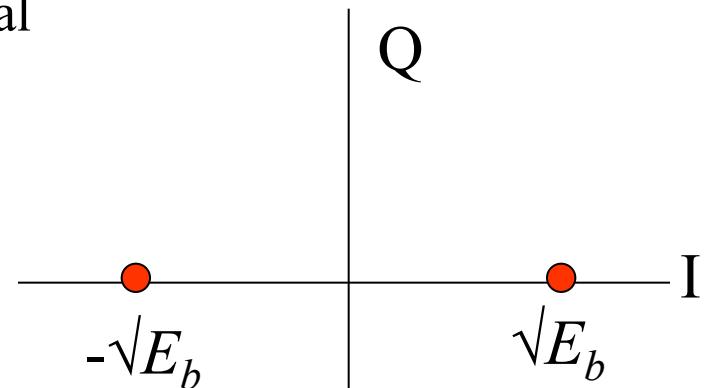

Constellation diagram