

# Other members of Thyristor Family

# Other Types of Thyristors

1. Gate Turnoff Thyristor (GTO)
2. DIAC
3. TRIAC
4. MOS-Controlled Thyristor (MCT)

# (1) GTO

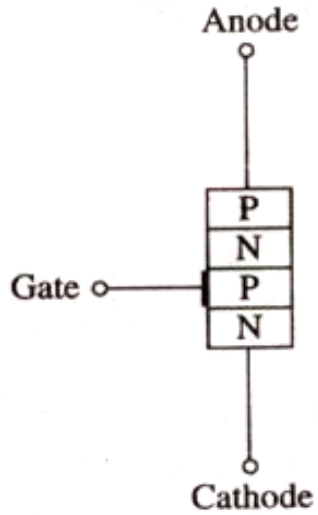

(a)

Structure

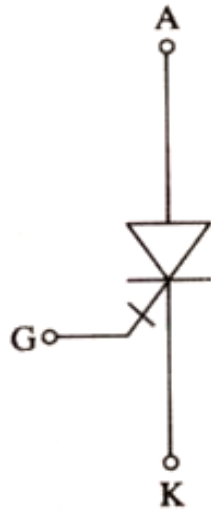

(b)

Symbol

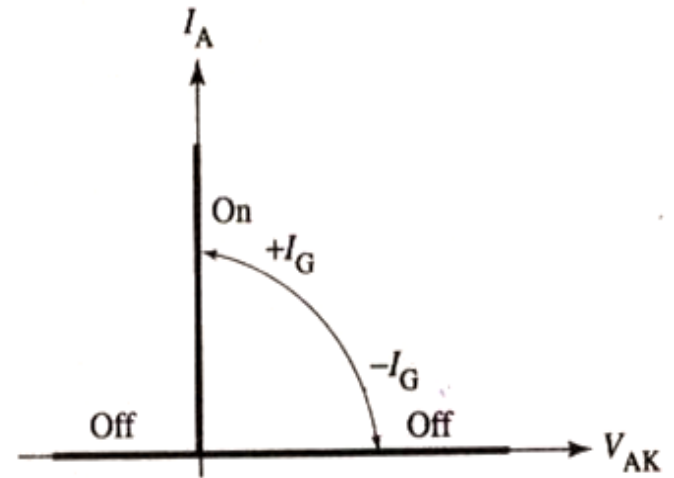

GTO Ideal VI characteristics

## (2) DIAC

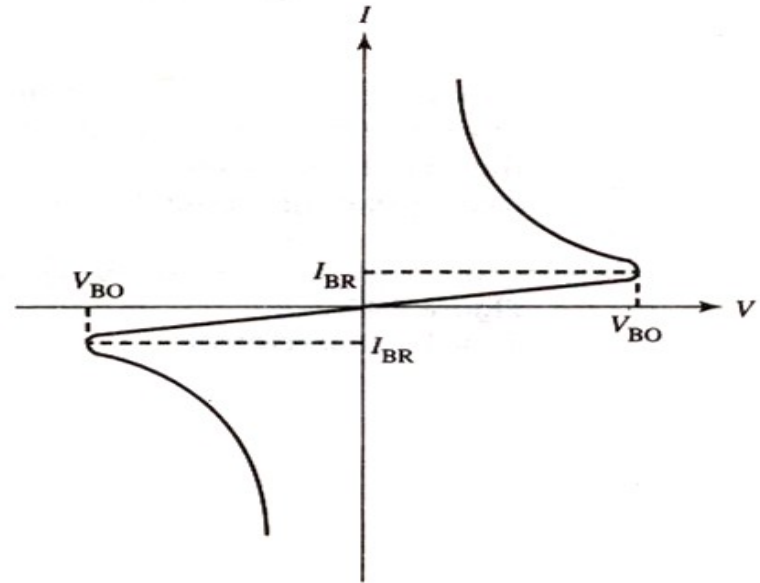
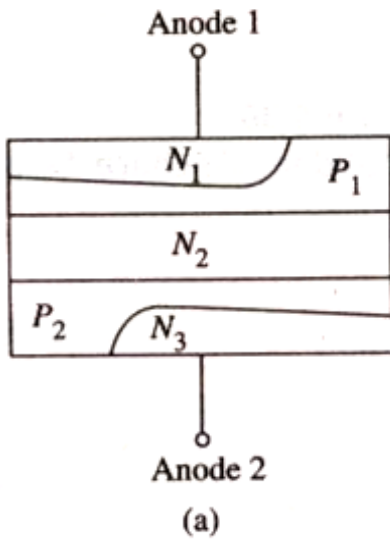

Structure  
Symbol

VI characteristics of diac

# (3) Triac

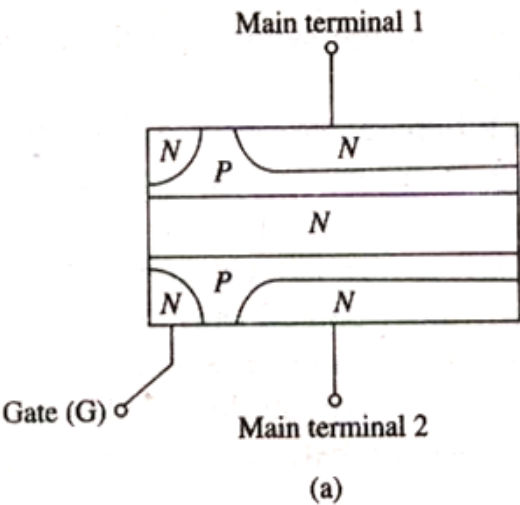

Structure



Symbol

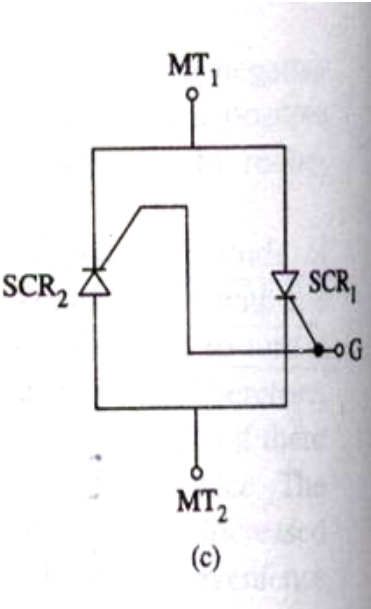

SCR equivalent circuit

# Triac VI characteristics

