

$$V_{dc} = V_{dm} \times \cos \alpha$$

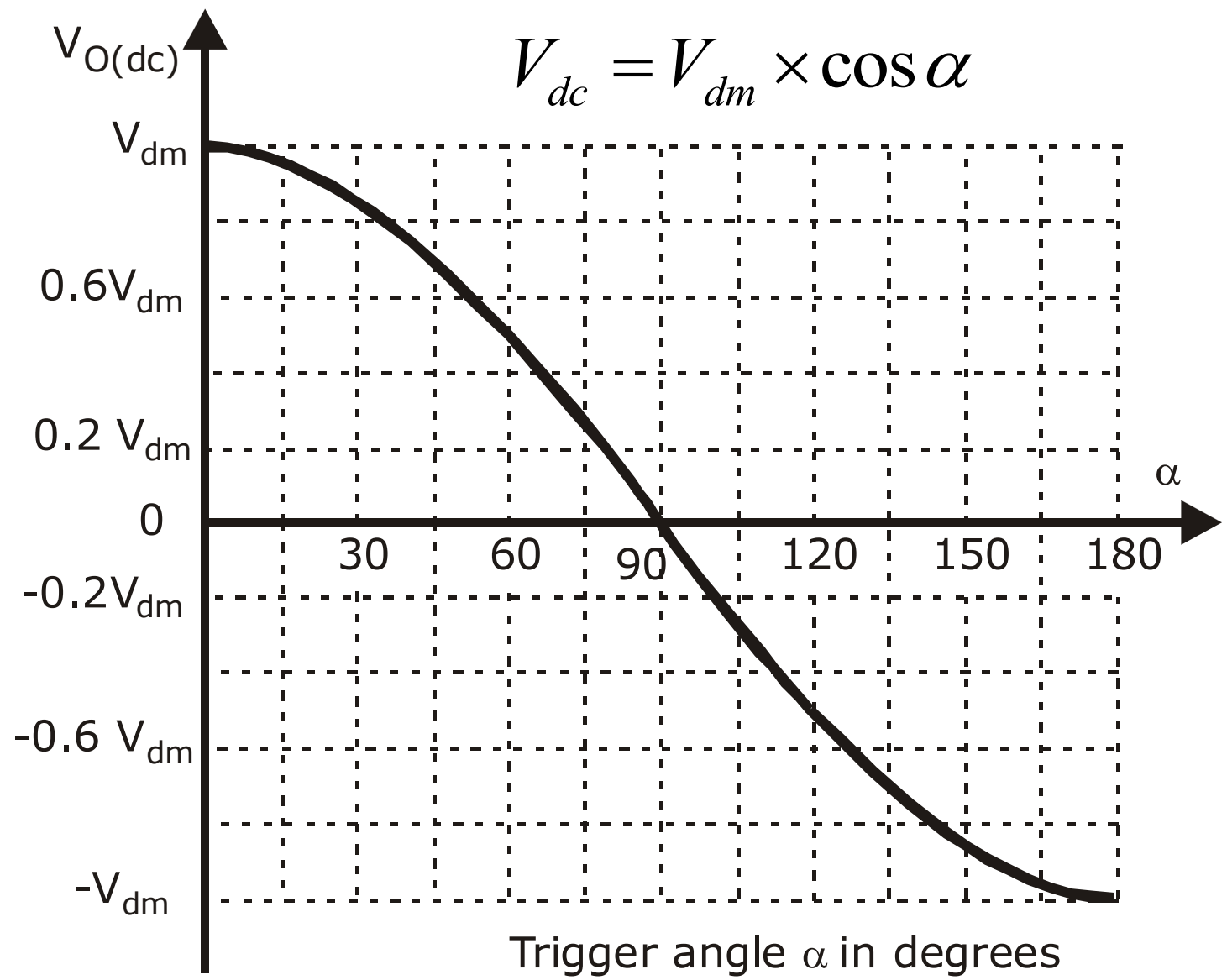

Trigger angle α in degrees

- During the period from $\omega t = \alpha$ to π the input voltage v_s and the input current i_s are both positive and the power flows from the supply to the load.
- The converter is said to be operated in the rectification mode

Controlled Rectifier Operation
for $0 < \alpha < 90^\circ$

During the period from $\omega t = \pi$ to $(\pi + \alpha)$, the input voltage v_S is negative and the input current i_S is positive and the output power becomes negative and there will be reverse power flow from the load circuit to the supply.
The converter is said to be operated in the inversion mode.

Line Commutated Inverter Operation
for $90^\circ < \alpha < 180^\circ$

Two Quadrant Operation of a Single Phase Full Converter

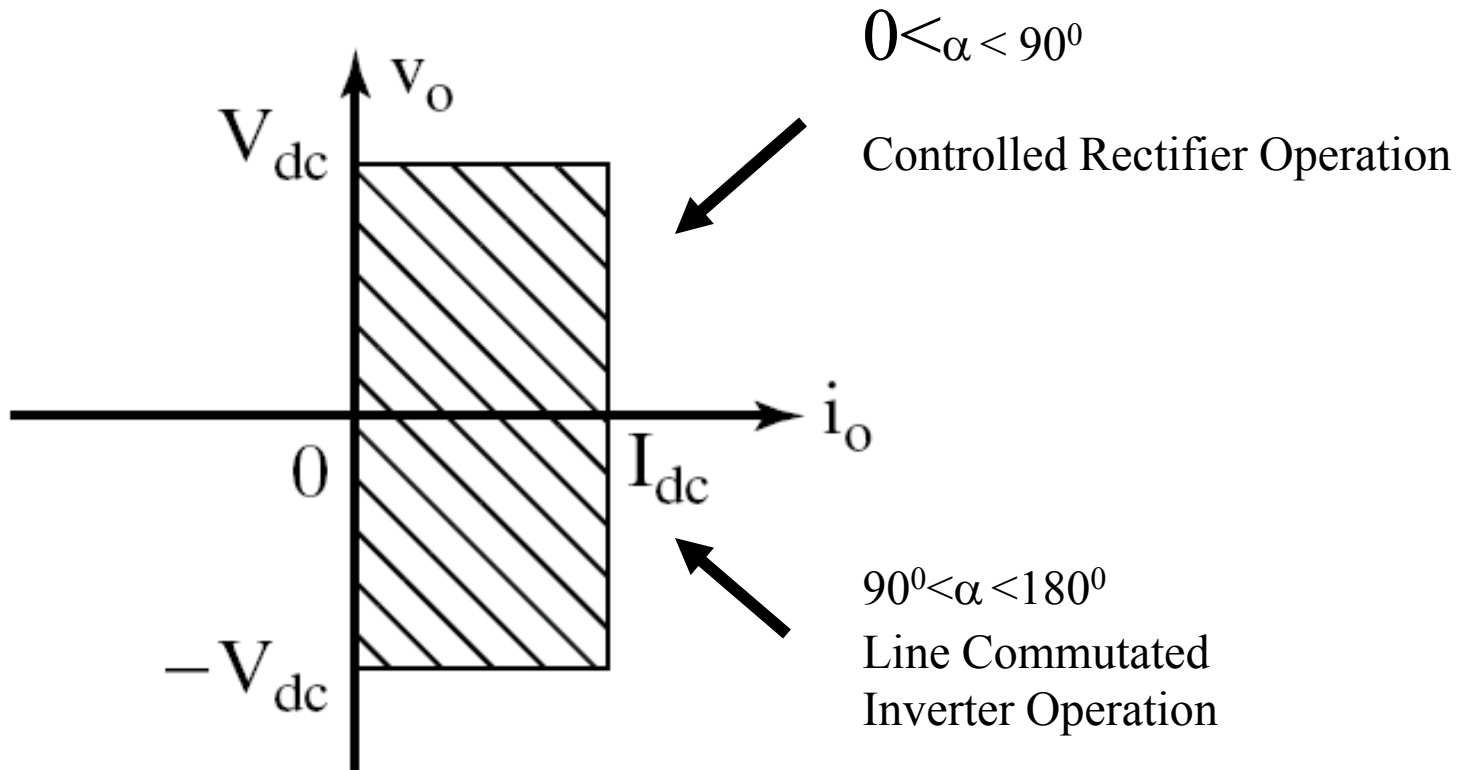

To Derive An
Expression For The
RMS Value Of The Output Voltage

The rms value of the output voltage
is calculated as

$$V_{O(RMS)} = \sqrt{\frac{1}{2\pi} \left[\int_0^{2\pi} v_o^2 \cdot d(\omega t) \right]}$$

The single phase full converter gives two output voltage pulses during the input supply time period and hence the single phase full converter is referred to as a two pulse converter. The rms output voltage can be calculated as

$$V_{O(RMS)} = \sqrt{\frac{2}{2\pi} \left[\int_{\alpha}^{\pi+\alpha} v_o^2 \cdot d(\omega t) \right]}$$

$$V_{O(RMS)} = \sqrt{\frac{1}{\pi} \left[\int_{\alpha}^{\pi+\alpha} V_m^2 \sin^2 \omega t . d(\omega t) \right]}$$

$$V_{O(RMS)} = \sqrt{\frac{V_m^2}{\pi} \left[\int_{\alpha}^{\pi+\alpha} \sin^2 \omega t . d(\omega t) \right]}$$

$$V_{O(RMS)} = \sqrt{\frac{V_m^2}{\pi} \left[\int_{\alpha}^{\pi+\alpha} \frac{(1 - \cos 2\omega t)}{2} . d(\omega t) \right]}$$

$$V_{O(RMS)} = \sqrt{\frac{V_m^2}{2\pi} \left[\int_{\alpha}^{\pi+\alpha} d(\omega t) - \int_{\alpha}^{\pi+\alpha} \cos 2\omega t . d(\omega t) \right]}$$

$$V_{O(RMS)} = \sqrt{\frac{V_m^2}{2\pi} \left[\frac{(\omega t)}{\alpha} \Big|_{\pi+\alpha} - \left(\frac{\sin 2\omega t}{2} \right) \Big|_{\pi+\alpha} \right]}$$

$$V_{O(RMS)} = \sqrt{\frac{V_m^2}{2\pi} \left[(\pi + \alpha - \alpha) - \left(\frac{\sin 2(\pi + \alpha) - \sin 2\alpha}{2} \right) \right]}$$

$$V_{O(RMS)} = \sqrt{\frac{V_m^2}{2\pi} \left[(\pi) - \left(\frac{\sin(2\pi + 2\alpha) - \sin 2\alpha}{2} \right) \right]};$$

$$\sin(2\pi + 2\alpha) = \sin 2\alpha$$

$$V_{O(RMS)} = \sqrt{\frac{V_m^2}{2\pi} \left[(\pi) - \left(\frac{\sin 2\alpha - \sin 2\alpha}{2} \right) \right]}$$

$$V_{O(RMS)} = \sqrt{\frac{V_m^2}{2\pi} (\pi) - 0} = \sqrt{\frac{V_m^2}{2}} = \frac{V_m}{\sqrt{2}}$$

$$\therefore V_{O(RMS)} = \frac{V_m}{\sqrt{2}} = V_S$$

Hence the rms output voltage is same as the rms input supply voltage

Thyristor Current Waveforms

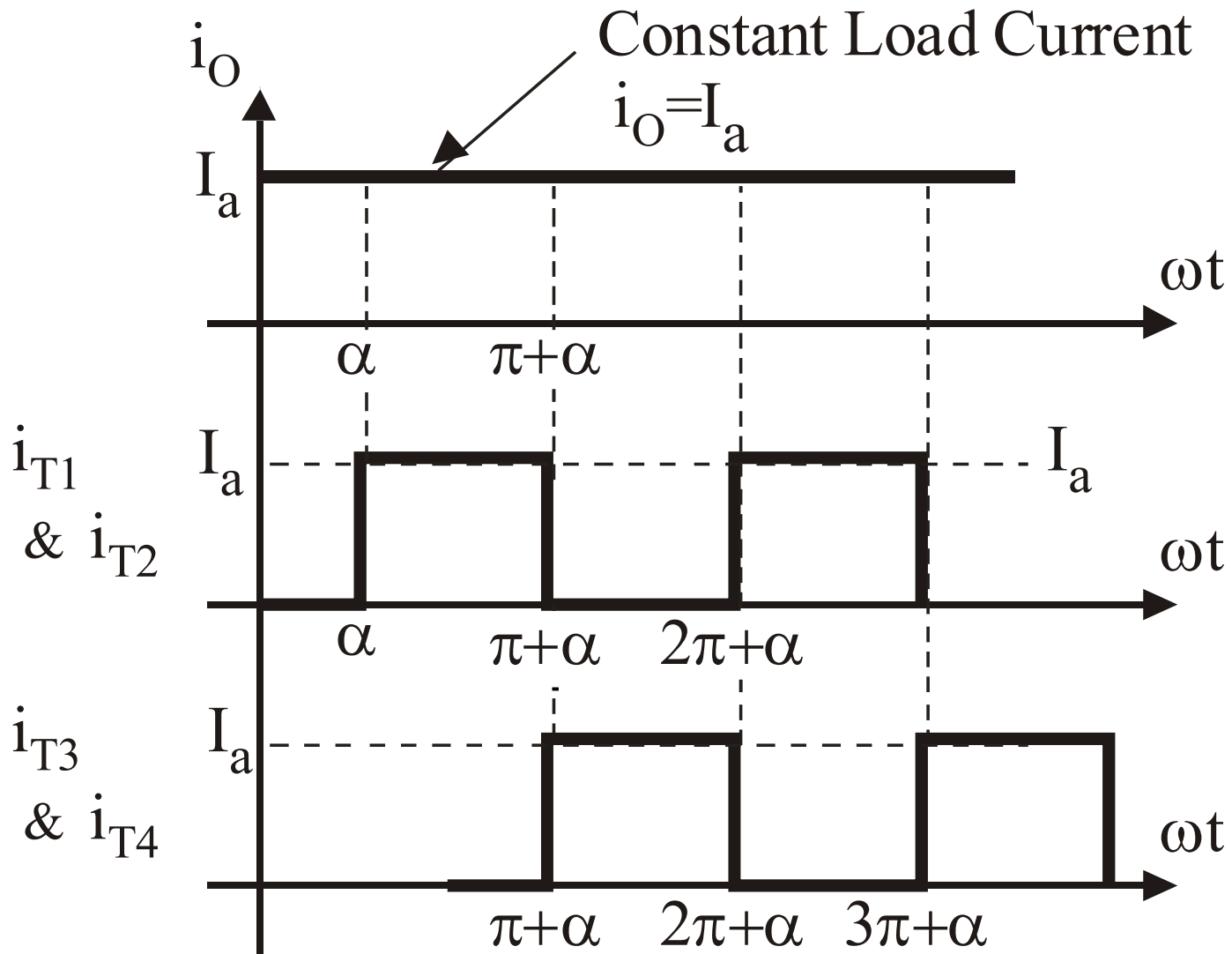

The rms thyristor current can be calculated as

$$I_{T(RMS)} = \frac{I_{O(RMS)}}{\sqrt{2}}$$

The average thyristor current can be calculated as

$$I_{T(Avg)} = \frac{I_{O(dc)}}{2}$$

Single Phase Dual Converter

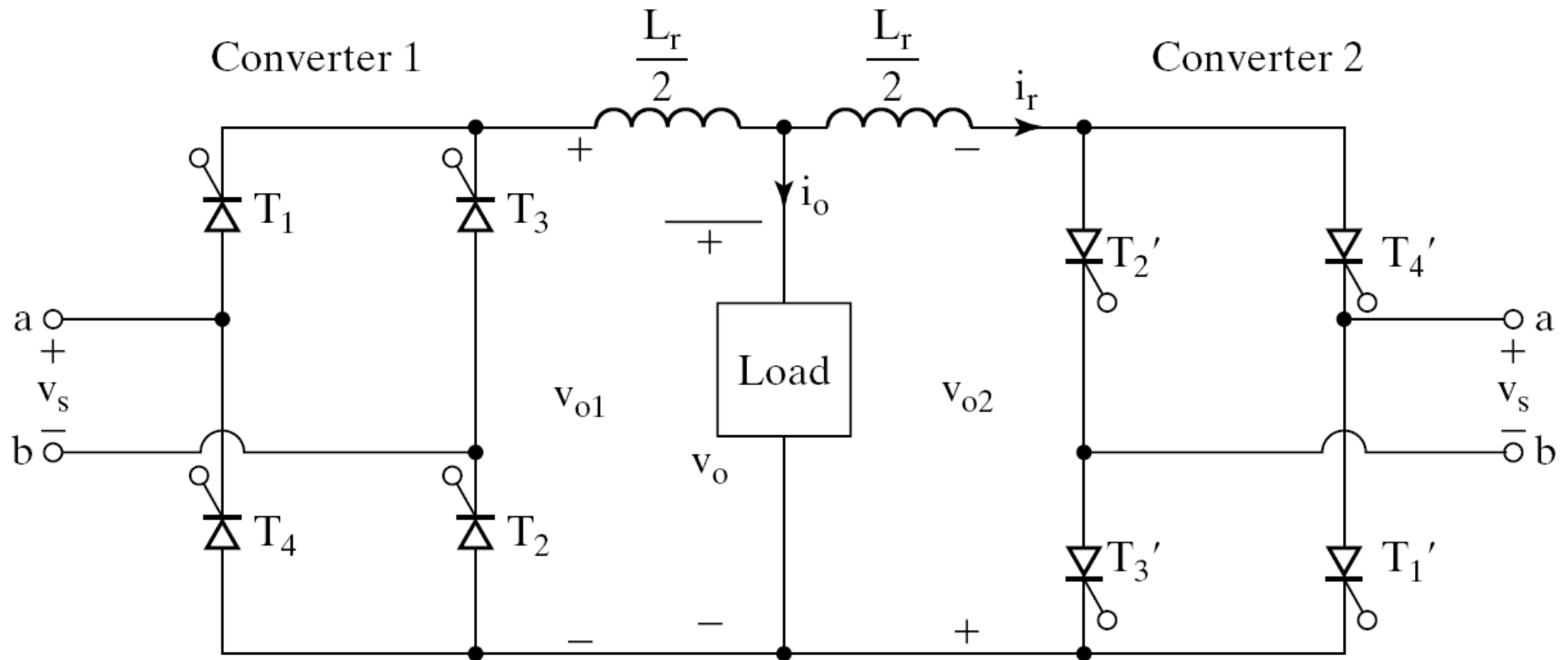

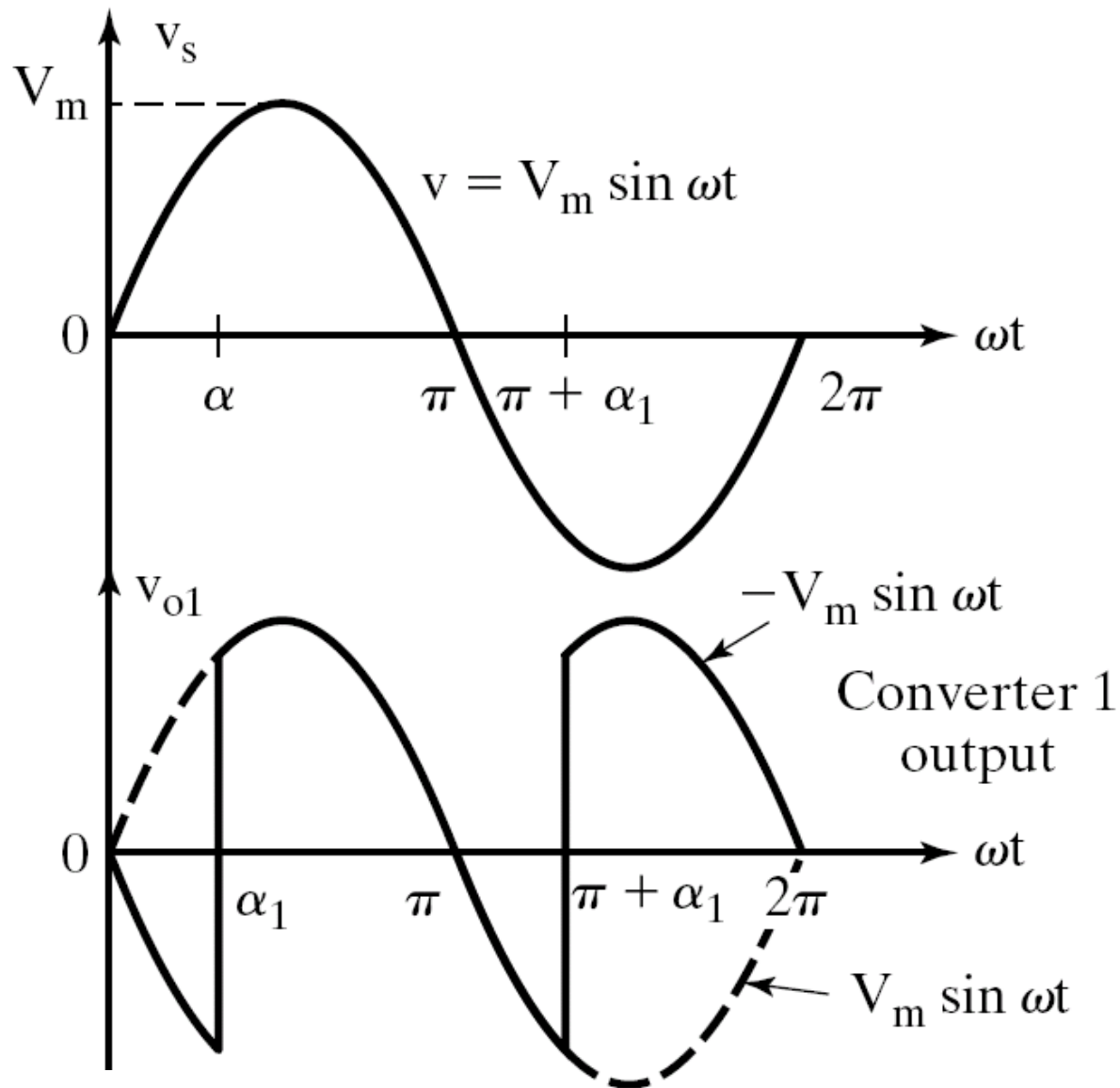

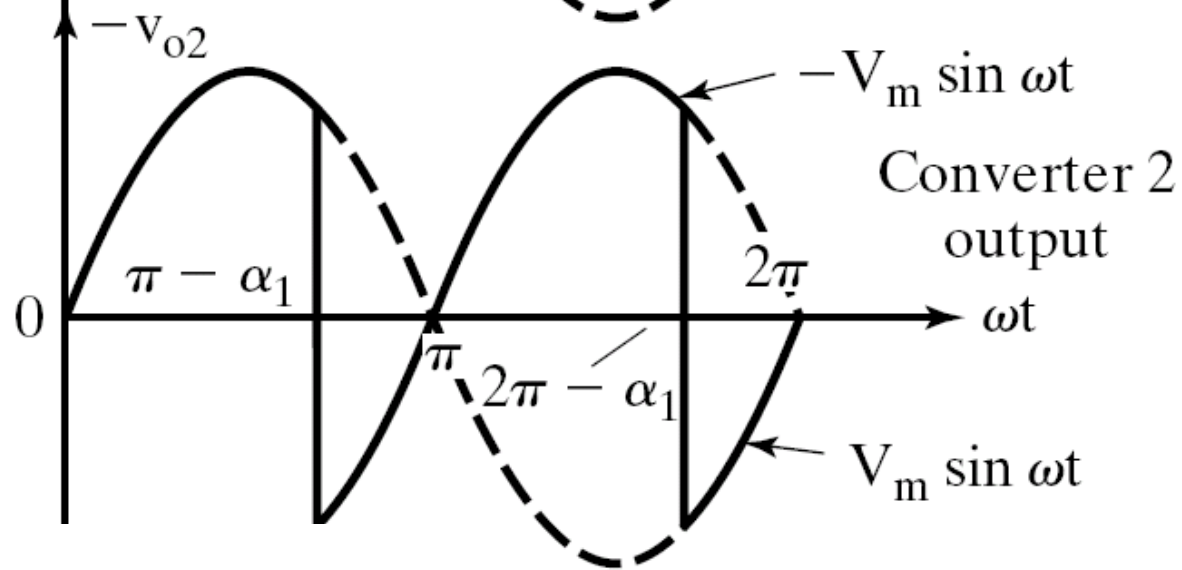
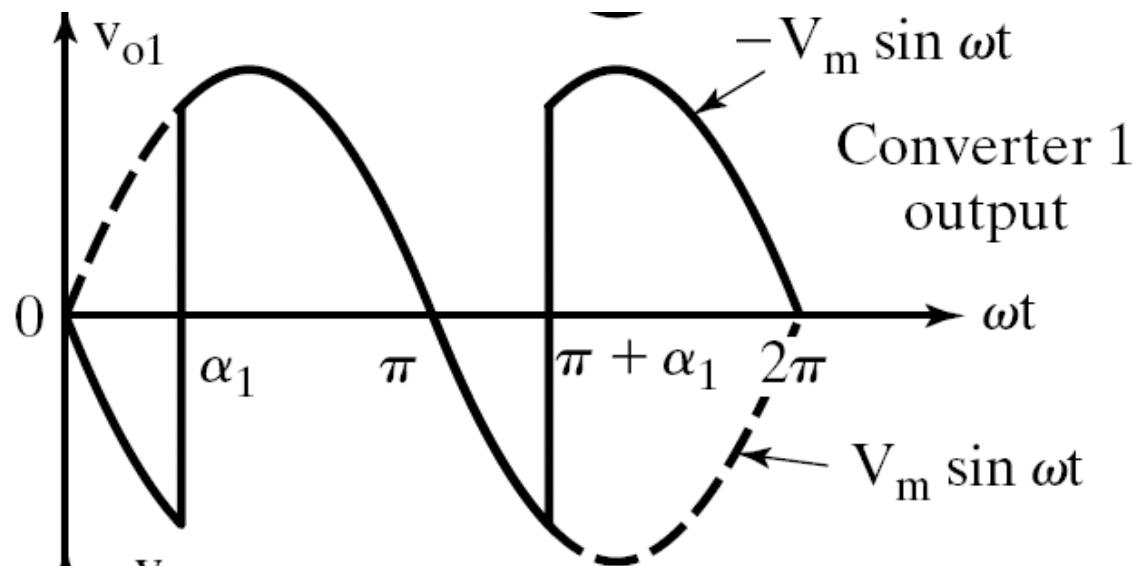

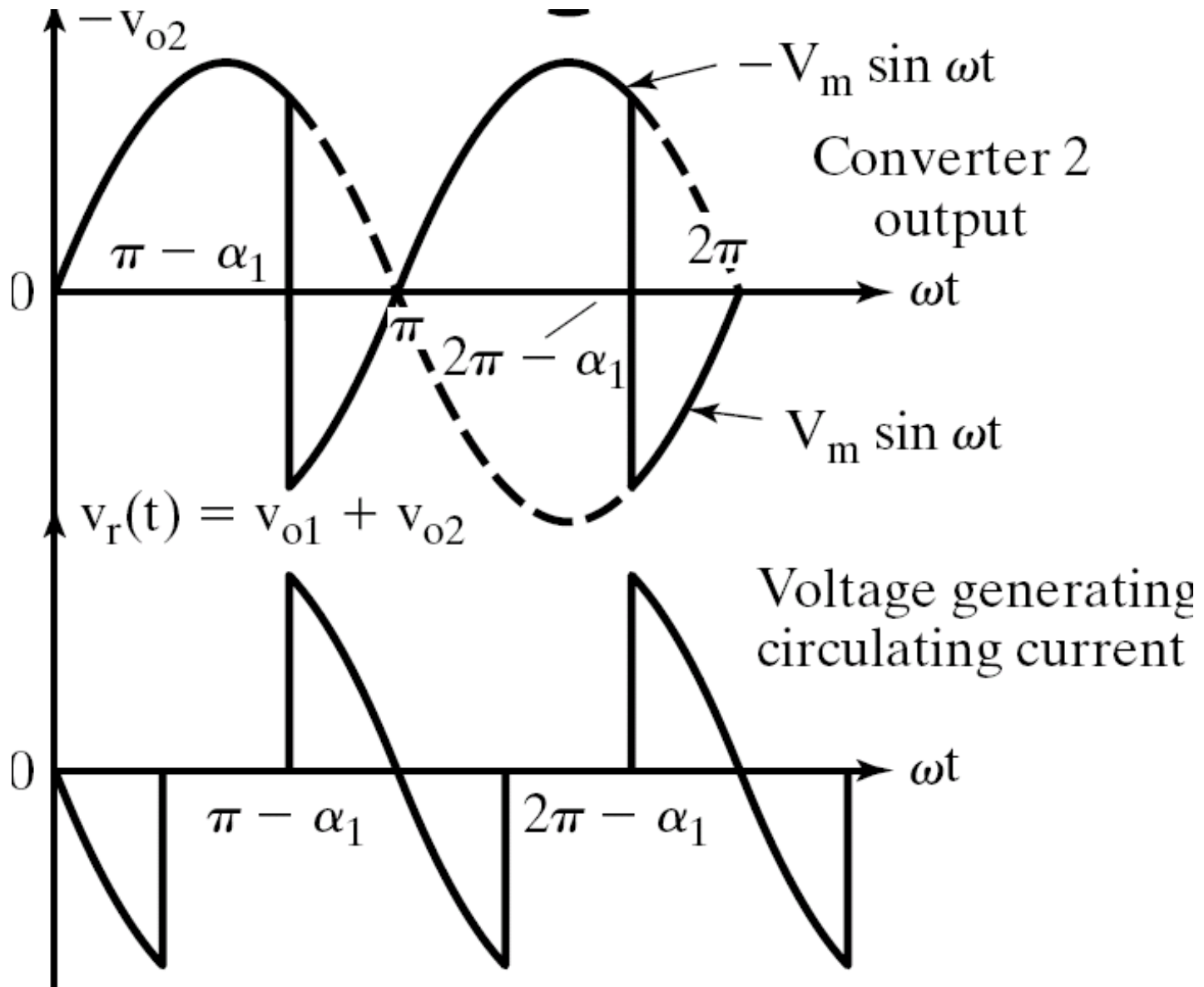

The average dc output voltage of converter 1 is

$$V_{dc1} = \frac{2V_m}{\pi} \cos \alpha_1$$

The average dc output voltage of converter 2 is

$$V_{dc2} = \frac{2V_m}{\pi} \cos \alpha_2$$

In the dual converter operation one converter is operated as a controlled rectifier with $\alpha < 90^0$ & the second converter is operated as a line commutated inverter in the inversion mode with $\alpha > 90^0$

$$\therefore V_{dc1} = -V_{dc2}$$

$$\frac{2V_m}{\pi} \cos \alpha_1 = \frac{-2V_m}{\pi} \cos \alpha_2 = \frac{2V_m}{\pi} (-\cos \alpha_2)$$

$$\therefore \cos \alpha_1 = -\cos \alpha_2$$

or

$$\cos \alpha_2 = -\cos \alpha_1 = \cos(\pi - \alpha_1)$$

$$\therefore \alpha_2 = (\pi - \alpha_1) \text{ or}$$

$$(\alpha_1 + \alpha_2) = \pi \text{ radians}$$

Which gives

$$\alpha_2 = (\pi - \alpha_1)$$